

Relay for OLTC Control & Transformer Monitoring

REGSys™ (REG-D, PAN-D)

- ▶ Wall-mounting housing
- ▶ Panel-mounting housing
- ▶ Plug-in module

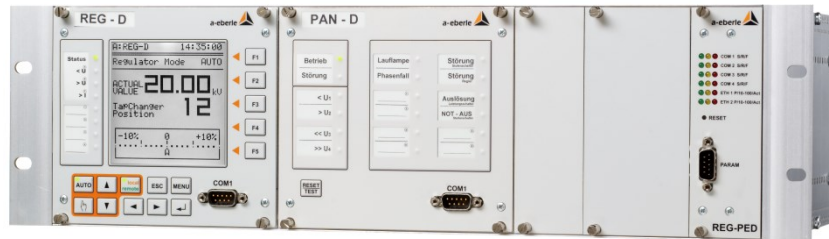

1. Application

The REGSys™ relay for OLTC Control & Transformer Monitoring is used to perform both complex and simple measurement, control and regulation tasks on tap-changing transformers. To achieve these tasks, the REG-D™ relay can be used with an array of add-on components, such as the PAN-D and PAN-A monitoring and supervisory modules, the BIN-D and ANA-D remote I/O modules, and an assortment of communication cards.

Each REG-D™ has Transducer and Statistical modes, as well as optional multi-channel Recorder, Transformer Monitoring Module (TMM) and ParaGramer.

Transducer Mode displays all of the relevant measured variables of the voltage network, while Statistical Mode provides a clear overview of the various switching operations of the tap changer.

Relays operating in parallel are connected via a fibre optic or copper ELAN bus, which enables the automatic sharing of relevant data. ParaGramer then detects which transformers have been switched into a parallel control scheme and displays this information via a single-line diagram.

The powerful TMM functions enable the continuous monitoring of various conditions within the transformer and tap changer. Information such as hot-spot temperature (IEC 60354 or IEC 60076) and transformer loss-of-life are calculated, and if necessary up to 6 cooling levels can be activated.

As an alternative to direct measurement, the U, I, tap position and $\cos(\varphi)$ value can also be transmitted to the REG-DA via SCADA client function (IEC 61850, IEC 60870-5-104), IEC61850-9-2 Sampled Values, IEC61850 GOOSE or by mA inputs, thereby eliminating the need for CT and VT cabling to the regulator.

The PAN-D relay is used to independently monitor the control voltage and to supervise signals from the relay to the tap changer.

The PAN-D relay generates a range of indications that make it easy to operate the transformer. For example, the voltage limits <U1, >U2, <<U3, >>U4, the tap changer in operation signal, and indications like 'Regulator fault' and 'Tap changer fault' are indicated via LED and relay contact.

Freely programmable inputs and outputs enable the implementation of application specific tasks.

A number of different communication cards are available for the REGSys™, with connections that range from copper RS232 to fibre optic Ethernet.

A variety of protocols are available to communicate with a SCADA system or RTU:

- IEC 61850
- IEC 60870 - 5 - 101 / 103 / 104
- DNP 3.0 via Ethernet
- DNP 3.0
- Profibus DP
- MODBUS RTU
- SPABUS

The REG-PED^{SV} is capable of most of these protocols and may be switched between them and configured using the free WinConfig software. WinConfig is specifically designed to provide a similar configuration interface for all of the protocols, thereby reducing engineering time.

The communication interfaces of the REG-D™ and PAN-D are equipped with cyber security features including role based access control (RBAC) with remote user authentication via e.g. the Radius protocol.

2. Characteristics of the REGSys™*

- Cyber security with role based access control (RBAC) and remote authentication via e.g. Radius
- Large backlit LCD (128 x 128)
- Measurement functions (U, I, P, Q, S, $\cos \varphi$, φ , $I \cdot \sin(\varphi)$, f)
- Recorder function (characteristic S2) with up to 256 recording channels and 108 MB internal memory (REG-D only)
- A three-channel line recorder function (characteristic S1) is also available for the PAN-D (with indication on REG-D's LCD)
- Statistics function (total number of switching operations, switching operations per tap, switching operations under load)
- Event recorder (logbook)
- Transformer monitoring functions to calculate the hot-spot temperature and lifetime consumption and to control the fans and oil pumps. In addition the moisture content in cellulose and the risk of bubble formation is evaluated
- ParaGramer function to view and automate the parallel connection of up to ten transformers
- 14 (16) freely programmable binary inputs
- 9 freely programmable binary outputs
- Freely programmable analogue mA in- or outputs
- PT100 direct input
- Direct input for tap position potentiometer (200 Ω ...20 k Ω total resistance)
- Regulation of three winding transformers
- Regulation of phase shifting transformers
- Regulation of transformer banks
- Control of capacitor banks
- Limit-value monitoring for all measured quantities
- 4 freely programmable and selectable setpoint values
- Dynamic adjustment of the setpoint values based on the load (Z-compensation, LDC)
- Programmable rated U and I values
- Open programmability enables implementation of PLC functions (background program)
- Peripheral bus (COM3) for additional interface modules (ANA-D, BIN-D, Modbus converter)
- Ability to enter externally measured quantities (gas-in-oil ratio, winding temperature, etc.) by communicating directly with the measuring devices through Modbus
- All of the measurements (including external measurements) and events can be transferred to SCADA
- Software to set parameters, program devices, view and archive data

*Characteristics may be available in REG-D™ or PAN-D or in both

3. Description

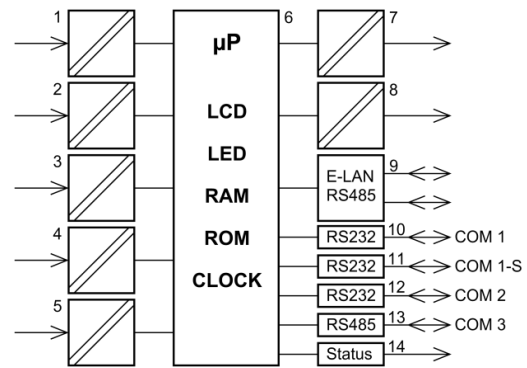

Functions of the REG-D™ relay

- 1 two current and two voltage measurement inputs
- 2 Analogue mA inputs, PT100 (optional)
- 3 Binary inputs
- 4 Input for resistance coded tap position (optional)
- 5 Power supply
- 6 Display and processing unit
- 7 Analogue outputs (optional)
- 8 Binary outputs
- 9 E-LAN connection (2 x RS485 with repeater function)
- 10 COM1, RS232
- 11 COM1-S, RS232 (can be used alternatively to COM1, on devices with characteristic S2 the COM1-S can be switched into COM4)
- 12 COM2, RS232 (on devices with characteristic S2 the COM2 can be split into COM2 and COM5)
- 13 COM3, RS485 (optional)
- 14 Status contact (life contact)

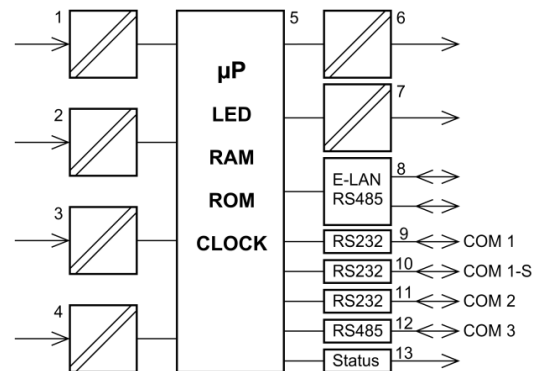

Functions of the PAN-D monitoring unit

- 1 Voltage measurement input
- 2 Binary inputs
- 3 Analogue mA inputs, PT100 (optional)
- 4 Power supply
- 5 Display and processing unit
- 6 Binary outputs
- 7 Analogue outputs (optional)
- 8 E-LAN connection (2 x RS485 with repeater)
- 9 COM1, RS232
- 10 COM1-S, RS232 (can be used alternatively to COM1)
- 11 COM2, RS232
- 12 COM3, RS485 (optional)
- 13 Status contact (life contact)

3.1 Regulator mode

The actual value and a fixed or load-dependent setpoint value are continually compared in the regulator, which then determines the correct commands for the transformer's tap changer. The regulator's parameters can be fine-tuned to the dynamic time behaviour of the grid voltage to obtain high control performance for a low number of switching operations.

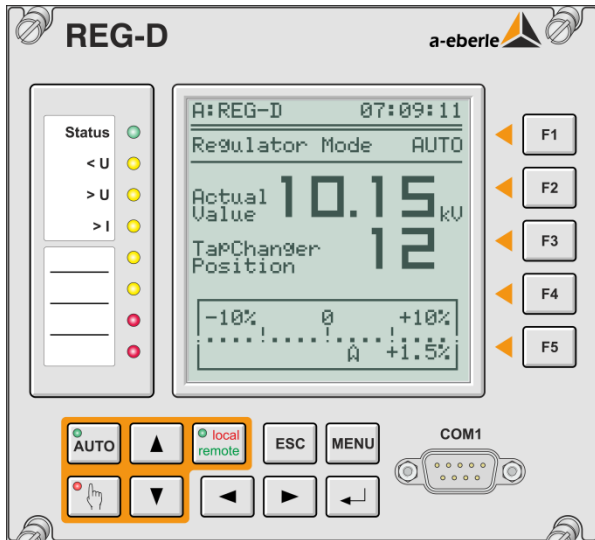

Connecting transformers in parallel

Each regulator is capable of operating in parallel with up to 9 other regulators, without the need for additional components.

A number of different parallel control schemes are available, fitting for transformers that operate in parallel on a single busbar, as well as those that are feeding the same grid from different substations.

Parallel control schemes are listed in Table 1 below:

Case	REG-D™ program	Conditions
Parallel operation on one or more busbars	$\Delta I \sin \varphi$	Identical transformers, identical or different tap steps
	$\Delta I \sin \varphi (S)$	Transformers with different nominal power, identical or different tap steps
	Master-Follower	Identical transformers, identical tap steps

Case	REG-D™ program	Conditions
free feed in	$\Delta \cos \varphi$	Any transformer, any tap size
Emergency program in the event of an ELAN failure	$\Delta \cos \varphi$	Any transformer, any tap size; for the programs $\Delta I \sin \varphi$ and $\Delta I \sin \varphi (S)$

Table 1 Parallel operation of transformers

3.2 Transducer mode

The values of all relevant variables of a three-wire, three-phase system with balanced or unbalanced load are calculated from the measured CT & VT inputs.

All of the measured and calculated values can then be viewed on the LCD display, or transferred by analogue signal and SCADA connection.

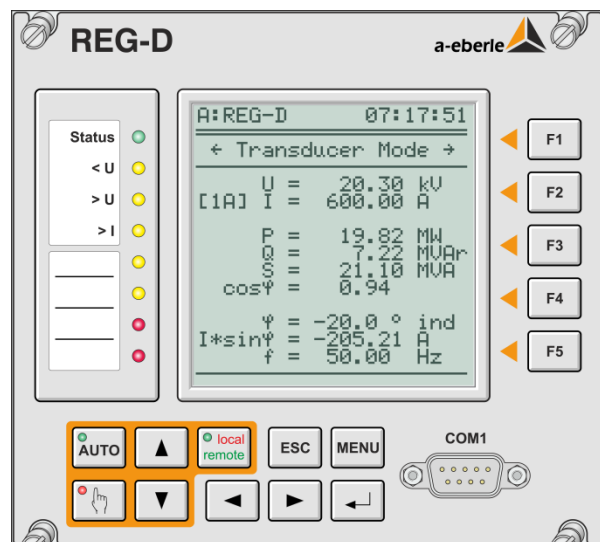

Measured quantities on the display

- Voltage U_{eff}
- Current I_{eff}
- Active power P
- Reactive power Q
- Apparent power S
- $\cos \varphi$
- Phase angle φ
- Reactive current $I * \sin \varphi$
- Frequency f
- Circulating reactive current (see page 2 of the transducer display)

We take care of it.

3.3 Recorder mode

Up to three selectable analogue values can be continuously recorded. Up to two of them can be displayed as a line chart with an adjustable time grid. The tap position*, setpoint value*, tolerance band, and Manual/Auto state, as well as the time and date are recorded in addition to these measured quantities. This enables the voltage and the time-correlated tap position to be viewed at any time, for example. The average storage time for voltage and tap position (1 channel) is approximately six weeks.

The stored values can also be retrieved and displayed by the Control software.

(*requires the voltage to be recorded on channel 1)

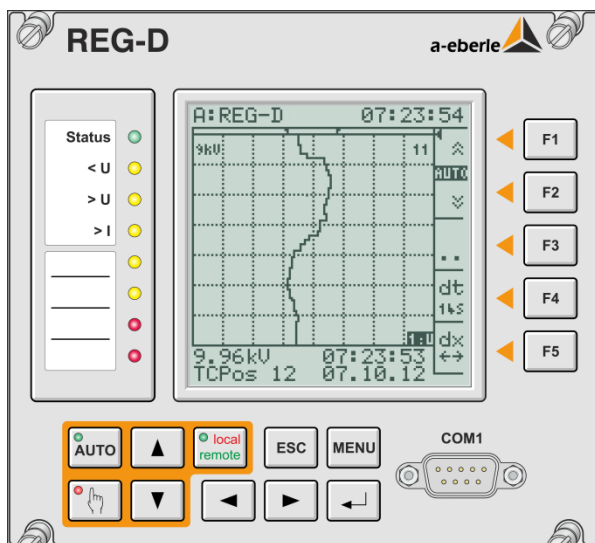

Regardless of the selected time grid (feed rate) of the display, all of the measurements are stored at a standard rate of 1 data point per second. Each data point then represents the arithmetic mean of 10 measurements that were generated at 100 ms intervals.

Storage behaviour in the case of an overflow	Overwrite with FIFO (First in First out)
Storage time (voltage plus tap)	< 18.7 days worst case on average > 1 month

3.4 Statistics mode

The Statistics mode records all of the tap changer's switching operations. Separate logs are stored for switching operations under load and without load.

This information can be used to analyse how many taps were made in a certain timeframe, as well as how often a particular tap was selected. This information is then used to fine-tune the regulator's settings.

The stored values can also be retrieved and displayed by the Control software, using the Service/Online module.

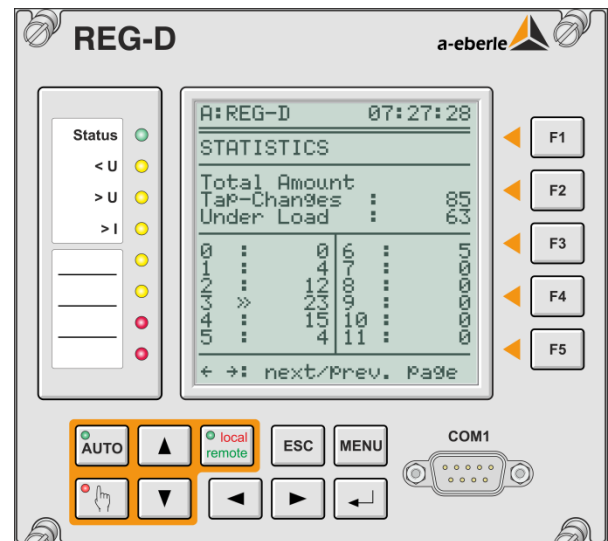

3.5 ParaGramer mode

ParaGramer is an efficient tool that automatically detects which transformers have been switched into a parallel control scheme, and displays this information via a single-line diagram.

The artificial word ParaGramer is a combination of the terms **parallel** and single-line **diagram**.

Paragrammer can monitor the positions of circuit breakers, isolators, bus ties and bus couplings. Based on the status of these inputs and of the regulators in the parallel scheme, the system automatically determines optimum tap positions for all of the transformers.

Multiple busbars are configurable on both the HV and LV sides of the transformers.

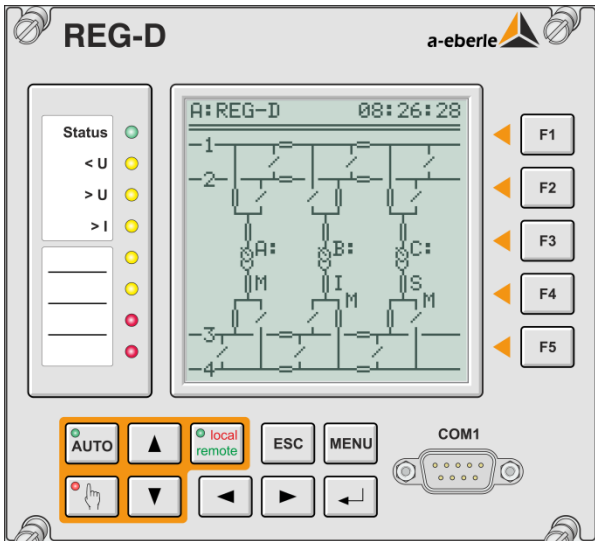

As shown in the graphic, both transformers A: and C: are working on busbar '3', while transformer B: is feeding into busbar '4'.

3.6 Transformer monitoring module TMM

The Transformer Monitoring module collects and calculates information about the condition of the transformer and tap changer.

The hot-spot temperature is calculated in accordance with IEC 60354 and IEC 60076, and is used to determine the transformer's loss of life.

The optional TM+ function evaluates the moisture content of the cellulose and the risk of bubble formation.

Up to 6 groups of fans and 2 oil pumps can be controlled to regulate the temperature of the transformer. The operating times of the fans and pumps are stored for maintenance purposes.

Oil temperature is measured either directly as a PT100 input or via a mA transducer, and also be recorded using the Recorder mode.

A total of three analogue input slots are available in the REG-D™, allowing the monitoring of several temperatures, oil levels, gas levels, and so on.

Please refer to characteristic group 'E' in the Order specifications for a list of the combination options.

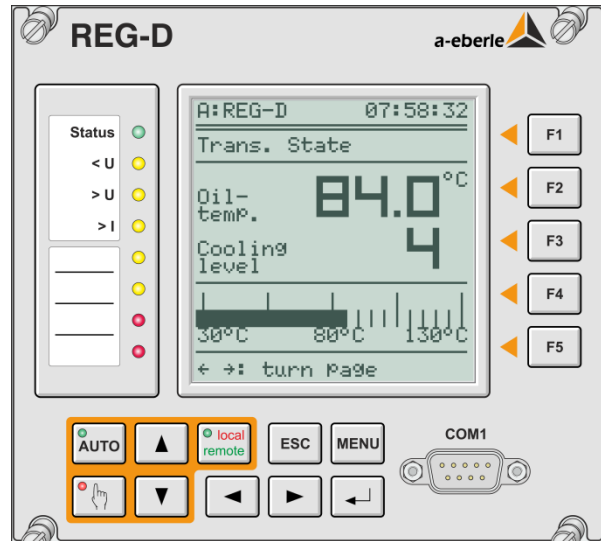

3.7 PAN-D Monitoring unit

The PAN-D monitoring unit is normally assigned to a REG-D™ and is connected via the E-LAN bus. When used in stand-alone mode, the PAN-D unit is used without bus connection and is thus a fully autonomous add-on monitoring unit.

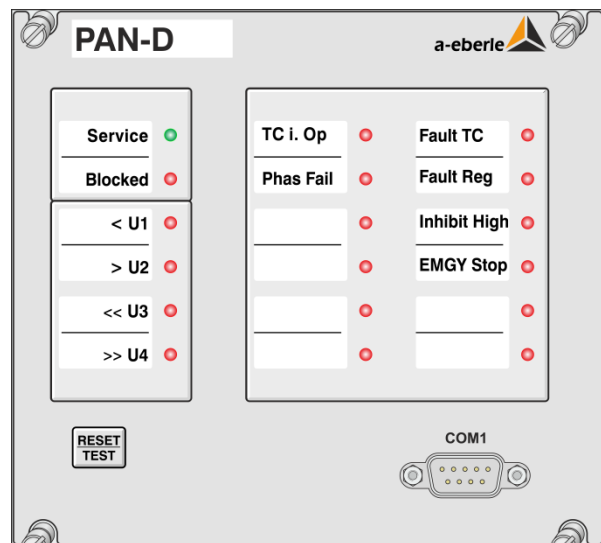

The parameters for the PAN-D monitoring unit are set either directly through the unit's interface or by using the keyboard and display of the regulator.

4. Technical specifications

*) Applies to both the REG-D™ and the PAN-D

Regulations and standards *)

- IEC 61010-1 / EN 61010-1
- IEC 61010-2-030 / EN 61010-2-030
- CAN/CSA C22.2 No. 1010.1-92
- IEC 60255-22-1 / EN 60255-22-1
- IEC 61326-1 / EN 61326-1
- IEC 60529 / EN 60529
- IEC 60068-1 / EN 60068-1
- IEC 60688 / EN 60688
- IEC 61000-6-2 / EN 61000-6-2
- IEC 61000-6-4 / EN 61000-6-4

The time mentioned at the isolation test voltage is applied during the routine test. For type testing the voltage is applied for the duration in accordance to the standard (e.g. 60s).

AC voltage inputs (U _E) *)	
Nominal input voltage U _n	100 VAC
Input voltage range	0 ... 160 VAC
Rated voltage	230 VAC
Frequency range	16... <u>50</u> ... <u>60</u> ...65 Hz
Crest factor @ U _r	≤ 2
Input resistance	100...102kΩ
Internal consumption	≤ 0.01mW/V ²
Bandwidth	420Hz
ADC	12 Bit, 24 samples/cycle
Over voltage category	300V CAT II / 150V CAT III
Isolation	reinforced *
Isolation test voltage	2.3kVAC, 5s

*The voltage measurement inputs can be interconnected with a 100kΩ resistor.

AC current input (I _E) only for REG-D™	
Nominal input current I _n	1A / 5A, selectable
Measurement range	0 ... 2.1·I _n
Rated current	10 A
Over load capacity	100 A für 1s
Frequency range	16... <u>50</u> ... <u>60</u> ...65 Hz
Crest factor @ I _n	≤ 3
Internal consump. @ 5A	≤ 0,5 VA
Bandwidth	420Hz
ADC	12 Bit, 24 samples/cycle
Over voltage category	300V CAT II / 150V CAT III

AC current input (I _E) only for REG-D™	
Isolation	reinforced, per channel
Isolation test voltage	2.3kVAC, 5s

Measured quantities *)	
True RMS voltages	U ₁₂ , (U ₂₃ , U ₃₁) (≤ 0.25%)
True RMS current	I ₁ , (I ₂ , I ₃) (≤ 0.25%)
Active power	P (≤ 0.5%)
Reactive power	Q (≤ 0.5%)
Apparent power	S (≤ 0.5%)
Power factor	cos φ (≤ 0.5%)
Phase angle	φ (≤ 0.5%)
Reactive current	I · sin φ (≤ 1%)
Frequency	f (≤ 0.05%)

Reference conditions *)	
Reference temperature	23°C ± 1 K
Input quantities	U _E = 0 ... 160 V I _E = 0 ... 1A / 0 ... 5A
Frequency	45 Hz...65 Hz
Shape of the curve	Sinusoidal, form factor 1.1107
Load (only for characteristics E91...E900)	R _n = 5 V / Y2 ± 1%
Other	IEC 60688 - Part 1

Ambient conditions *)	
Temperature range	
Function (Housing)	-10 °C ... +50 °C
Function (plug-in module)	-10 °C ... +60 °C
Transport and storage	-25 °C ... +65 °C
Dry cold	IEC 60068-2-1, - 10°C / 16 h
Dry heat	IEC 60068-2-2, + 55°C / 16 h
Humid heat constant	IEC 60068-2-78 + 40°C / 93% / 2 days
Humid heat cyclical	IEC 60068-2-30 12+12 h, 6 cycles +55°C / 93%
Drop and topple	IEC 60068-2-31 100 mm drop height, unpacked
Vibration	IEC 60255-21-1, Class 1
Shock	IEC 60255-21-2, Class 1
Earthquake resistance	IEC 60255-21-3, Class 1

Binary inputs (BI) *)	
General	
Signal frequency	0 ... 70Hz
AC debouncing	40 ... 70Hz
Form factor	≤ 1.16
Binary input type HV (High voltage)	
Input voltage	≤ 250V (r.m.s.)
Input resistance	107...116kΩ
Over voltage category	300V CAT II
Isolation between input groups	basic isolation ^{a)}
Isolation against touchable parts	reinforced
Isolation test voltage	2.3kVAC, 5s
Binary input type LV (Low voltage)	
Input voltage	≤ 50V (r.m.s.)
Input resistance	6.5...8.1kΩ
Characteristic D1 – Binary inputs 1 ... 8, isolated	
Characteristic X25 – Binary inputs 17...24, isolated	
Input type	HV
H – Level	≥ 48 V
L - Level	< 10 V
Characteristic D1 – Binary input groups 9...12,13...16	
Characteristic X25 – B. input groups 25...28, 29...32	
Input type	LV
H – Level	≥ 10 V
L - Level	< 5 V
Characteristic D2 – Binary inputs 1 ... 16, isolated	
Characteristic X15 – Binary inputs 17 ... 32, isolated	
Input type	HV
H – Level	≥ 48 V
L - Level	< 10 V
Characteristic D3 - Binary inputs 1 ... 16, isolated	
Characteristic X24 - Binary inputs 17 ... 32, isolated	
Input type	LV
H – Level	≥ 10 V
L - Level	< 5 V
Characteristic D4 - Binary inputs 1 ... 16, isolated	
Characteristic X29 - Binary inputs 17 ... 32, isolated	
Input type	HV
H – Level	≥ 80 V
L - Level	< 40 V
Characteristic D5 - Binary inputs 1 ... 16, isolated	
Characteristic X28 - Binary inputs 17 ... 32, isolated	
Input type	HV
H – Level	≥ 176 V
L - Level	< 88 V

a) In the case of DC voltage, the sum of the operating voltages of adjacent binary input groups must not exceed 300V!

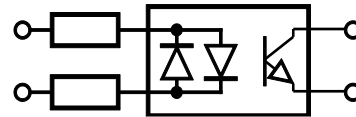

Simplified diagram of a binary input

Binary outputs (BO) *)	
max. switching frequency	≤ 1 Hz
Contact load	AC: 250 V, 5 A (cosφ = 1.0) AC: 250 V, 3 A (cosφ = 0.4) Switching capacity max. 1250 VA DC: 30 V, 5 A resistive DC: 30 V, 3.5 A L/R=7 ms DC: 110 V, 0.5 A resistive DC: 220 V, 0.3 A resistive Switching capacity max. 150 W
Inrush current	250 V AC, 30 V DC 10 A for max. 4 s
Switching operations	≥ 5·10 ⁵ electrical
Over voltage category	300V CAT II
Isolation between outputs or output groups	Basic isolation ^{b) c)}
Isolation against touchable parts	reinforced
Isolation test voltage	2.3kVAC, 5s

b) In case of DC voltage, the sum of the working voltages of adjacent outputs or output groups must not exceed 300V!

c) If an output or an output group is connected to a dangerous active circuit, the neighboring outputs or output groups must not be connected with SELV circuits or other touchable parts!

Auxiliary voltage *)			
Characteristic	H0	H1/H11	H2
AC (internal)	75...185 V	-	-
AC			
Nom. voltage range	-	100 ... 240 V	-
Total voltage range	-	90 ... 264 V	-
DC Nom. volt. range	-	100 ... 300 V	20 ... 70 V
AC power consumption	≤ 35 VA	≤ 35 VA (H1) ≤ 45 VA (H11)	-
DC power consumption	-	≤ 25 W (H1) ≤ 35 W (H11)	≤ 25 W
Frequency	50/60 Hz	50/60 Hz	DC
Microfuse	T1 250 V	T1 250 V	T2 250 V
Over voltage category	300V CAT II	300V CAT II	150V CAT II
Isolation	reinforced	reinforced	reinforced
Isolation test voltage	2.3kVAC, 5s	2.3kVAC, 5s	1.4kVAC, 5s

The following applies to all characteristics:

Voltage dips of ≤ 25 ms result neither in data loss nor malfunctions. Fuses are time lag (slow blow) type.

We take care of it.

Electrical safety *)	
Safety class	I
Degree of pollution	2
Standards	IEC 61010-1 IEC 61010-2-030

Electromagnetic compatibility *)	
EMC requirements	EN 61326-1 Equipment class A Continuous, unmonitored operation, industrial location and EN 61000-6-2 and 61000-6-4
Interference emissions	
Conducted and radiated emission	EN 61326 Table 3 EN 61000-6-4
Harmonic currents	EN 61000-3-2
Voltage fluctuations and flicker	EN 61000-3-3
Disturbance immunity	EN 61326 Table A1 and EN 61000-6-2
ESD	IEC 61000-6-2 8 kV/16 kV contact/air
Electromagnetic fields	IEC 61000-4-3 80 – 2700 MHz: 10 V/m
Fast transient	IEC 61000-4-4 2 kV/1 kV
Surge voltages	IEC 61000-4-5 4 kV/2 kV
Conducted HF signals	IEC 61000-4-6 150 kHz – 80 MHz: 10 V _{rms}
Power-frequency magnetic fields	IEC 61000-4-8 100 A/m (50 Hz), continuous 1000 A/m (50 Hz), 3 s
Voltage dips	IEC 61000-4-11 30% / 20 ms, 60% / 1 s
Voltage interruptions	IEC 61000-4-11 100% / 5s
Damped oscillations	IEC 61000-4-12, Class 3, 2.5 kV

Analogue inputs (AI) *)	
Quantity	See order specifications
Input range Y1...Y2	-20 mA...0...20 mA points Y1 and Y2 are programmable
Control limit	± 1.2 Y2
Voltage drop	≤ 1.5 V
Isolation	functional, per channel
Common-mode rejection	> 80 dB

<i>Series-mode rejection</i>	> 60 dB / Decade from 10 Hz
<i>Overload capacity</i>	≤ 50 mA continuous
<i>Error limit</i>	0.5%

Analogue outputs (AO) *)	
Quantity	See order specifications
Output range Y1...Y2	-20 mA...0...20 mA points Y1 and Y2 programmable
Control limit	± 1.2 Y2
Potential isolation	Functional, per channel
Load range	0 ≤ R ≤ 8 V / Y2
Alternating component	< 0.5% of Y2

Temperature input PT100 *)	
Quantity	up to three PT100 inputs are possible
Type of connection	Three-wire circuit
Current through sensor	< 8 mA
Isolation	functional
Line compensation	No compensation required
Transmission behaviour	linear

Resistance input (tap position potentiometer)		
Characteristic	R1	R3
Quantity	See order specifications	
Connection	Three-wire / Four-wire with open wire detection	
Total resistance in the resistor chain	180 Ω ... 2 kΩ	2 kΩ ... 20 kΩ
Resistance per tap	5...100 Ω	50 Ω ... 2 kΩ
Number of taps	≤ 38	
Isolation	functional	
Current through resistor chain	≤ 25 mA	≤ 2.5 mA

Communication interfaces			
Name	Standard	Wires	Isolation
COM1	RS232	4, GND	-
COM1-S	RS232	4, GND	functional
COM2	RS232	4, GND	functional
COM3	RS422	4, GND	functional
E-LAN-L	RS485/422	2/4, GND	functional
E-LAN-R	RS485/422	2/4, GND	functional
DCF77	RS485	2, GND	functional

Device real time clock *)	
Accuracy	+/- 20 ppm 0 ... 10 ppm with Charact. S2
Backup battery	Lithium button cell 3V, Type CR1632

Limit value monitoring *)	
Limit values	programmable
Response times	programmable
Alarm indicators	LED programmable

Display (REG-D™ only)	
LC - Display	128 x 128 graphic display
Back-lighting	LED, automatic switch off after 15 minutes

Indicator elements (LEDs)		
Color	Quantity	Freely programmable quantity
Green	1 (1)	-- (--)
Yellow	5 (--)	5 (--)
Red	2 (17)	2 (6)

Values in () for PAN-D, Quantity without Manual/Auto and Local/Remote LEDs on the REG-D

Storage *)	
Firmware and recorder data characteristic S2	Flash memory
Device characteristics and calibration data	serial EEPROM with ≥ 1000 k write/read cycles
Other data and recorder data Characteristic S1	MRAM, Backup to flash memory possible

5. Mechanical design

Plug-in module *)	
Front panel	Plastic, RAL 7035 grey on aluminium brackets
Height	3 U (132.5 mm)
Width	28 HP (142.2 mm)
Printed circuit board	160 mm x 100 mm
Weight	≤ 1.5 kg
Protection type	
— Plug-in module	IP 00
— Female multipoint connector	IP 00
Mounting	in conformity with DIN 41494 Part 5
Plug-in connector	DIN 41612

5.1 Position of the male or female multipoint connectors

The male multipoint connectors are firmly connected to the device's printed circuit board, meaning that the female multipoint connectors must be mounted in specific positions in the housing or the module rack. A specific position number determines the reference point for the mounting of the guide holders and the connection elements on the back of the module rack/housing.

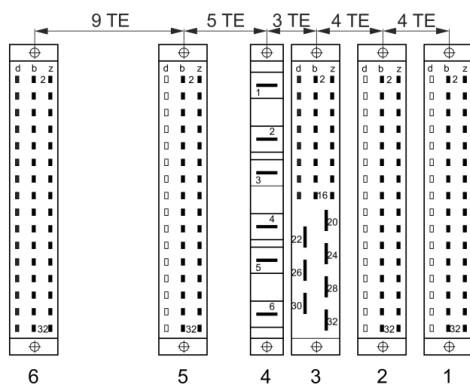

Position of the REG-D™ socket connectors

Position numbers						
socket connector	1	2	3	4	5	6
PCB card guide	n	-	-	-	-	n+26
Screws	n	n+4	n+8	n+11	n+16	n+25

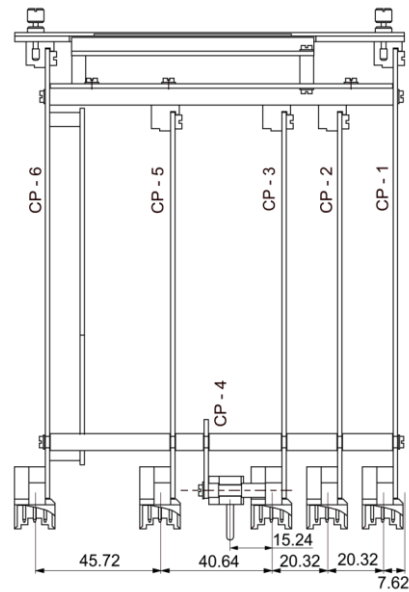

Position of the REG-D™ blade connectors

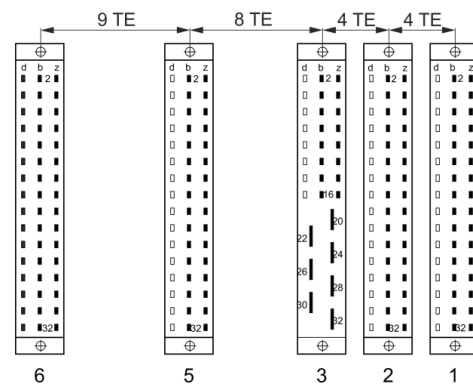

Position of the PAN-D socket connectors

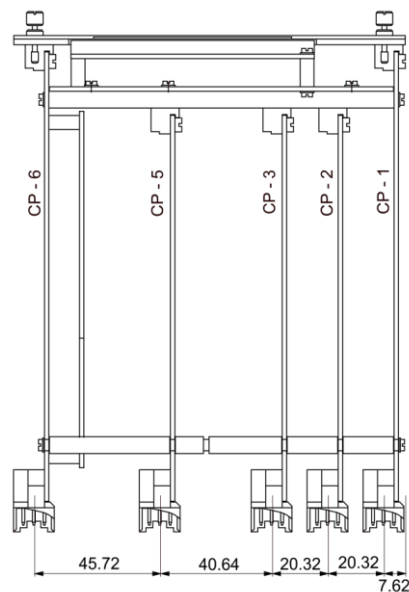

Position of the PAN-D blade connectors

5.2 Pin assignment of the REG-D™

Socket connector 1; (binary outputs)					
Raise (2 contact pairs) 1 NCC + 1 NOC	R1	Pole	b2 b4	NCC NOC	z2 z4
Lower (2 contact pairs) 1 NCC + 1 NOC	R2	Pole Pole	b8 b10	NCC NOC	Z8 z10
Freely programmable	R3	Pole	b14	NOC	z14
Freely programmable	R4	Pole	b16	NOC	z16
Freely programmable	R5	Pole	b20	NOC	Z20
Manual/Auto (converter)		Pole	b22	Automatic	Z22
		Man	b24		
Status		Pole	b26	NOC/NCC	Z24
Binary outputs (BO) 4 relays freely programmable	GND R6...R9				Z28
		NOC R6	b30	NOC R8	Z30
		NOC R7	b32	NOC R9	Z32



The status contact is either NOC or NCC based on characteristic U. This can be changed at a later stage by soldering a bridge.

Socket connector 2; (binary inputs) Characteristic D1					
Raise	E1	+	b2	-	z2
Lower	E2	+	b4	-	z4
Inhibit	E3	+	b6	-	z6
Fast switching	E4	+	b8	-	z8
Manual/Auto	E5	+	b10	-	z10
Manual	E6	+	b12	-	z12
Freely programmable	E7	+	b14	-	z14
Freely programmable	E8	+	b16	-	z16
BCD 1	E9	+	b24	-	b32
BCD 2	E10	+	b26	-	
BCD 4	E11	+	b28	-	z32
BCD 8	E12	+	b30	-	
BCD 10	E13	+	z24	-	
BCD 20	E14	+	z26	-	
BCD -	E15	+	z28	-	
Freely programmable	E16	+	z30	-	

Socket connector 2; (binary inputs) Characteristics D2...D5					
Raise	E1	+	b2	-	z2
Lower	E2	+	b4	-	z4
Inhibit	E3	+	b6	-	z6
Fast switching	E4	+	b8	-	z8
Manual/Auto	E5	+	b10	-	z10
Manual	E6	+	b12	-	z12
Freely programmable	E7	+	b14	-	z14
Freely programmable	E8	+	b16	-	z16
BCD 1	E9	+	b18	-	z18
BCD 2	E10	+	b20	-	z20
BCD 4	E11	+	b22	-	z22
BCD 8	E12	+	b24	-	z24
BCD 10	E13	+	b26	-	z26
BCD 20	E14	+	b28	-	z28
BCD -	E15	+	b30	-	z30
Freely programmable	E16	+	b32	-	z32



All inputs except E5 and E6 are freely programmable. The tables for the socket connector 2 show a sample allocation.

Socket connector 3; (measuring voltage, auxiliary voltage)					
DC output (max. 5 W)	+5V	d2, b2, z2	GND	d4, b4, z4	
Measuring voltage U1	U1a	20	U1b**	22	
Measuring voltage U2*	U2a**	26	U2b	24	
Auxiliary voltage U _H	L(+)	28	N(-)	30	PE 32

*only available for characteristics M2, M3 and M9

**for characteristic M2 (ARON), pin 26 is internally connected to pin 22. The connection is L1 (pin 20), L2 (pin 22) and L3 (pin 24).

Socket connector 4; (alternating current input)				
Measuring current I _{E1}	s1	1	s2	2
Measuring current I _{E2} *	s1	3	s2	4

*only available for characteristics M2 or M9



The current measuring inputs are equipped with special male and female socket connectors that short-circuit the current transformer when they are removed from the device. This means that the device does not have to be short-circuited externally.



Socket connector 4 is numbered from top to bottom (1 to 6). The contact with description 6 is at the top of the male socket connector in the REG-D for design reasons. This means that the male socket connector is numbered 6 to 1 from top to bottom (embossing on the male socket connector).

Socket connector 5; (binary inputs) Characteristic X25					
Freely programmable	E17	+	b2	-	z2
Freely programmable	E18	+	b4	-	z4
Freely programmable	E19	+	b6	-	z6
Freely programmable	E20	+	b8	-	z8
Freely programmable	E21	+	b10	-	z10
Freely programmable	E22	+	b12	-	z12
Freely programmable	E23	+	b14	-	z14
Freely programmable	E24	+	b16	-	z16
Freely programmable	E25	+	b24	-	b32
Freely programmable	E26	+	b26	-	
Freely programmable	E27	+	b28	-	
Freely programmable	E28	+	b30	-	
Freely programmable	E29	+	z24	-	z32
Freely programmable	E30	+	z26	-	
Freely programmable	E31	+	z28	-	
Freely programmable	E32	+	z30	-	

Socket connector 5; (binary inputs) Characteristics X15, 24, 28, 29					
Freely programmable	E17	+	b2	-	z2
Freely programmable	E18	+	b4	-	z4
Freely programmable	E19	+	b6	-	z6
Freely programmable	E20	+	b8	-	z8
Freely programmable	E21	+	b10	-	z10
Freely programmable	E22	+	b12	-	z12
Freely programmable	E23	+	b14	-	z14
Freely programmable	E24	+	b16	-	z16
Freely programmable	E25	+	b18	-	z18
Freely programmable	E26	+	b20	-	z20
Freely programmable	E27	+	b22	-	z22
Freely programmable	E28	+	b24	-	z24
Freely programmable	E29	+	b26	-	z26
Freely programmable	E30	+	b28	-	z28
Freely programmable	E31	+	b30	-	z30
Freely programmable	E32	+	b32	-	z32

Socket connector 5; (binary outputs) Characteristic X01				
Relay 10	Pole	b2	NOC	z2
Freely programmable	NCC	b4		
Relay 11	Pole	b6	NOC	z6
Freely programmable	NCC	b8		
Relay 12	Pole	b10	NOC	z10
Freely programmable	NCC	b12		

Socket connector 5; (binary outputs) Characteristic X01				
Relay 13	Pole	b14	NOC	z14
Freely programmable	NCC	b16		
Relay 14	Pole	b18	NOC	z18
Freely programmable	NCC	b20		
Relay 15	Pole	b22	NOC	z22
Freely programmable	NCC	b24		
Relay 16	Pole	b26	NOC	z26
Freely programmable	NCC	b28		
Relay 17	Pole	b30	NOC	z30
Freely programmable	NCC	b32		

Socket connector 5; (SCADA interface) Characteristic XW1					
COM1/RxD	d2	COM1/GND	b2	COM1/TxD	z2
COM1/CTS	d4	COM1/GND	b4	COM1/RTS	z4
COM1/PE	d6	COM1/PE	b6	COM1/PE	z6
free	d8	free	b8	free	z8
CPU/PE	d10	CPU/PE	b10	CPU/PE	z10
VCC/+5 V DC	d12	VCC/+5 V DC	b12	VCC/+5 V DC	z12
GND/5 V DC	d14	GND/5 V DC	b14	GND/5 V DC	z14
Fibre optic/Rx	d16	free	b16	Fibre optic/Tx	z16
free	d18	free	b18	free	z18
RS485/P (A)	d20	free	b20	RS485/N (B)	z20
RS485 PE	d22	RS485 PE	b22	RS485 PE	z22
COM3/TxD	d24	COM3/RxD	b24	COM3/RTS	z24
COM2/PE	d26	COM2/PE	b26	COM2/PE	z26
free	d28	free	b28	COM3/CTS	z28
COM2/RxD	d30	COM2/GND	b30	COM2/TxD	z30
COM2/CTS	d32	COM2/GND	b32	COM2/RTS	z32



REG-D/PAN-D CPU and the SCADA interface communicate through the COM2 interface.

Communication with the SCADA system can take place optionally through fibre optic cable, RS485 or RS232 (COM1). The fibre optic cable requires a separate module.

Socket connector 6; (analogue inputs and outputs; interfaces)					
free	d2	Analogue channel 1 +	b2	Analogue channel 2 +	z2
DCF GND	d4	Analogue channel 1 -	b4	Analogue channel 2 -	z4
DCF EA+	d6	E-LAN left EA +	b6	E-LAN right EA +	z6
DCF EA-	d8	E-LAN left EA -	b8	E-LAN right EA -	z8
E-LAN left GND	d10	E-LAN left E +	b10	E-LAN right E +	z10
E-LAN right GND	d12	E-LAN left E -	b12	E-LAN right E -	z12
free	d14	Analogue channel 3 +	b14	Analogue channel 4 +	z14
COM1-S/4* TxD	d16	Analogue channel 3 -	b16	Analogue channel 4 -	z16
COM1-S/4* RTS	d18	free	b18	free	z18
COM1-S/4* GND	d20	COM2 TxD	b20	COM2 RTS COM5 TxD**	z20
COM1-S/4* RxD	d22	COM2 RxD	b22	COM2 CTS COM5 RxD**	z22
COM1-S/4* CTS	d24	COM2 GND COM5 GND**	b24	free	z24
free	d26	Analogue channel 5 +	b26	Analogue channel 6 +	z26
free	d28	Analogue channel 5 -	b28	Analogue channel 6 -	z28
free	d30	COM3 Tx +	b30	COM3 Rx +	z30
COM3 GND	d32	COM3 Tx -	b32	COM3 Rx -	z32

*COM 4 is only available on devices with feature S2 since 09/2014

**COM 5 is only available on devices with feature S2 since 09/2014 and firmware version ≥ 3.29 and ESCC2 version ≥ 10

5.3 Pin assignment of the PAN-D

Socket connector 1; (binary outputs)					
Inhibit high	R1	Pole Pole	b2 b4	NOC NOC	z2 z4
EMERGENCY OFF tap-changer motor drive	R2	Pole Pole	b8 b10	NOC NOC	z8 z10
raise interlock	R3	Pole	b14	NOC	z14
lower interlock	R4	Pole	b16	NOC	z16
Freely programmable	R5	Pole	b20	NOC	z20
Freely programmable	R6	Pole	b26	NOC	z24
Status	Pole		b22		
	Failure		b24	Operation	z22

Socket connector 2; (binary inputs) Characteristic D1					
TC. in operation	E1	+	b2	-	z2
Freely programmable	E2	+	b4	-	z4
Freely programmable	E3	+	b6	-	z6
Freely programmable	E4	+	b8	-	z8
Freely programmable	E5	+	b10	-	z10
Freely programmable	E6	+	b12	-	z12
Freely programmable	E7	+	b14	-	z14
Freely programmable	E8	+	b16	-	z16
Freely programmable	E9	+	b24	-	b32
Freely programmable	E10	+	b26	-	
Freely programmable	E11	+	b28	-	
Freely programmable	E12	+	b30	-	z32
Freely programmable	E13	+	z24	-	
Freely programmable	E14	+	z26	-	
Freely programmable	E15	+	z28	-	
Freely programmable	E16	+	z30	-	

Socket connector 2; (binary inputs) Characteristics D2...D5					
TC. in operation	E1	+	b2	-	z2
Freely programmable	E2	+	b4	-	z4
Freely programmable	E3	+	b6	-	z6
Freely programmable	E4	+	b8	-	z8
Freely programmable	E5	+	b10	-	z10
Freely programmable	E6	+	b12	-	z12
Freely programmable	E7	+	b14	-	z14
Freely programmable	E8	+	b16	-	z16
Freely programmable	E9	+	b18	-	z18
Freely programmable	E10	+	b20	-	z20
Freely programmable	E11	+	b22	-	z22
Freely programmable	E12	+	b24	-	z24
Freely programmable	E13	+	b26	-	z26
Freely programmable	E14	+	b28	-	z28
Freely programmable	E15	+	b30	-	z30
Freely programmable	E16	+	b32	-	z32



All of the PAN-D's binary inputs are freely programmable from firmware version 2.22 onwards. Up to version 2.21, input 1 is allocated to the function TC in Operation. The tables for the socket connector 2 show the standard allocation.

We take care of it.

Socket connector 3; (measuring voltage, auxiliary voltage)					
DC output (max. 5 W)	+5V	d2, b2, z2	GND	d4, b4, z4	
Measuring voltage 1	U1a	20	U1b**	22	
Measuring voltage 2	U2a**	26	U2b	24	
Auxiliary voltage U _H	L(+)	28	N(-)	30	PE 32

** for characteristic M1, pin 26 is internally connected to pin 22. The connection is L1 (pin 20), L2 (pin 22) and L3 (pin 24).

Socket connector 5; (binary outputs)				
Tap changer failure	Pole	b2	NOC	z2
	NCC	b4		
Regulator failure	Pole	b6	NOC	z6
	NCC	b8		
<U1	Pole	b10	NOC	z10
	NCC	b12		
>U2	Pole	b14	NOC	z14
	NCC	b16		
«U3	Pole	b18	NOC	z18
	NCC	b20		
»U4	Pole	b22	NOC	z22
	NCC	b24		
Fast circuit switching	Pole	b26	NOC	z26
	NCC	b28		
Freely programmable	Pole	b30	NOC	z30
	NCC	b32		

Socket connector 6; (analogue inputs and outputs; interfaces)					
free	d2	Analogue channel 1 +	b2	Analogue channel 2 +	z2
DCF GND	d4	Analogue channel 1 -	b4	Analogue channel 2 -	z4
DCF EA+	d6	E-LAN left EA +	b6	E-LAN right EA +	z6
DCF EA-	d8	E-LAN left EA -	b8	E-LAN right EA -	z8
E-LAN left GND	d10	E-LAN left E +	b10	E-LAN right E +	z10
E-LAN right GND	d12	E-LAN left E -	b12	E-LAN right E -	z12
free	d14	Analogue channel 3 +	b14	Analogue channel 4 +	z14
COM1-S TxD	d16	Analogue channel 3 -	b16	Analogue channel 4 -	z16
COM1-S RTS	d18	free	b18	free	z18
COM1-S GND	d20	COM2 TxD	b20	COM2 RTS	z20
COM1-S RxD	d22	COM2 RxD	b22	COM2 CTS	z22
COM1-S CTS	d24	COM2 GND	b24	free	z24
free	d26	Analogue channel 5 +	b26	Analogue channel 6 +	z26
free	d28	Analogue channel 5 -	b28	Analogue channel 6 -	z28
free	d30	COM3 Tx +	b30	COM3 Rx +	z30
COM3 GND	d32	COM3 Tx -	b32	COM3 Rx -	z32

6. Block diagrams

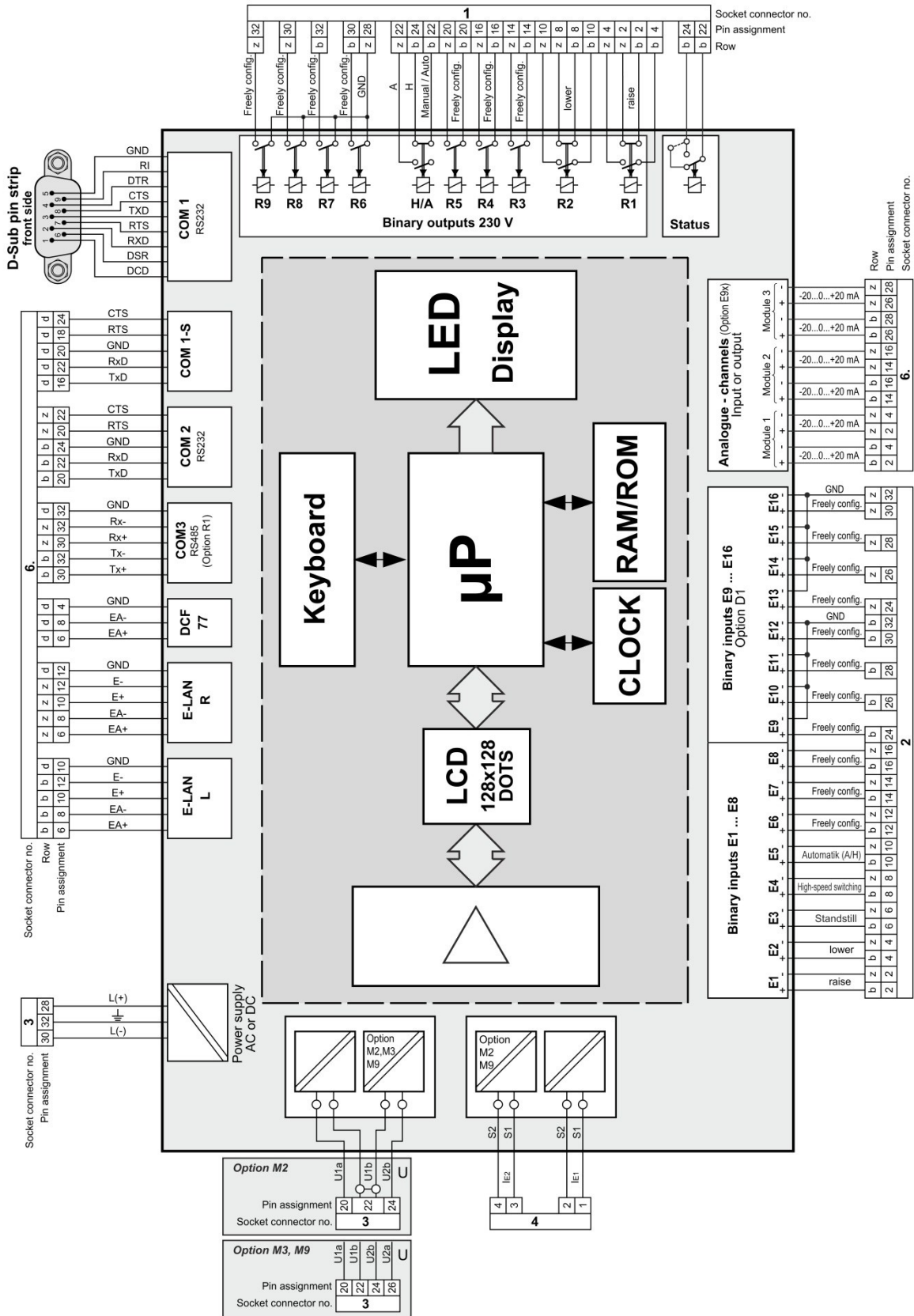

Block diagram REG-D™ Characteristic D1

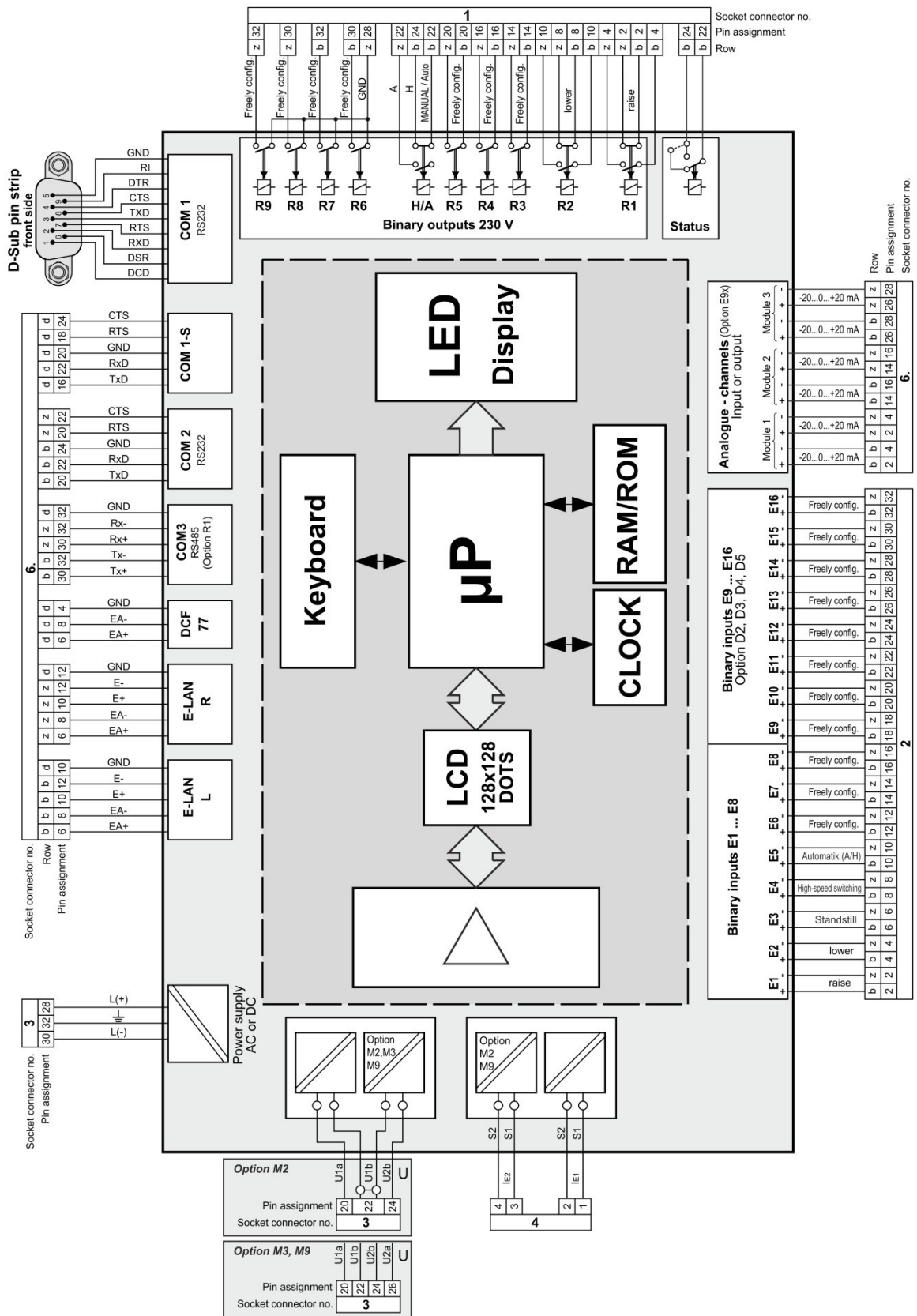

Block diagram REG-D™ Characteristic D2 / D3 / D4 / D5

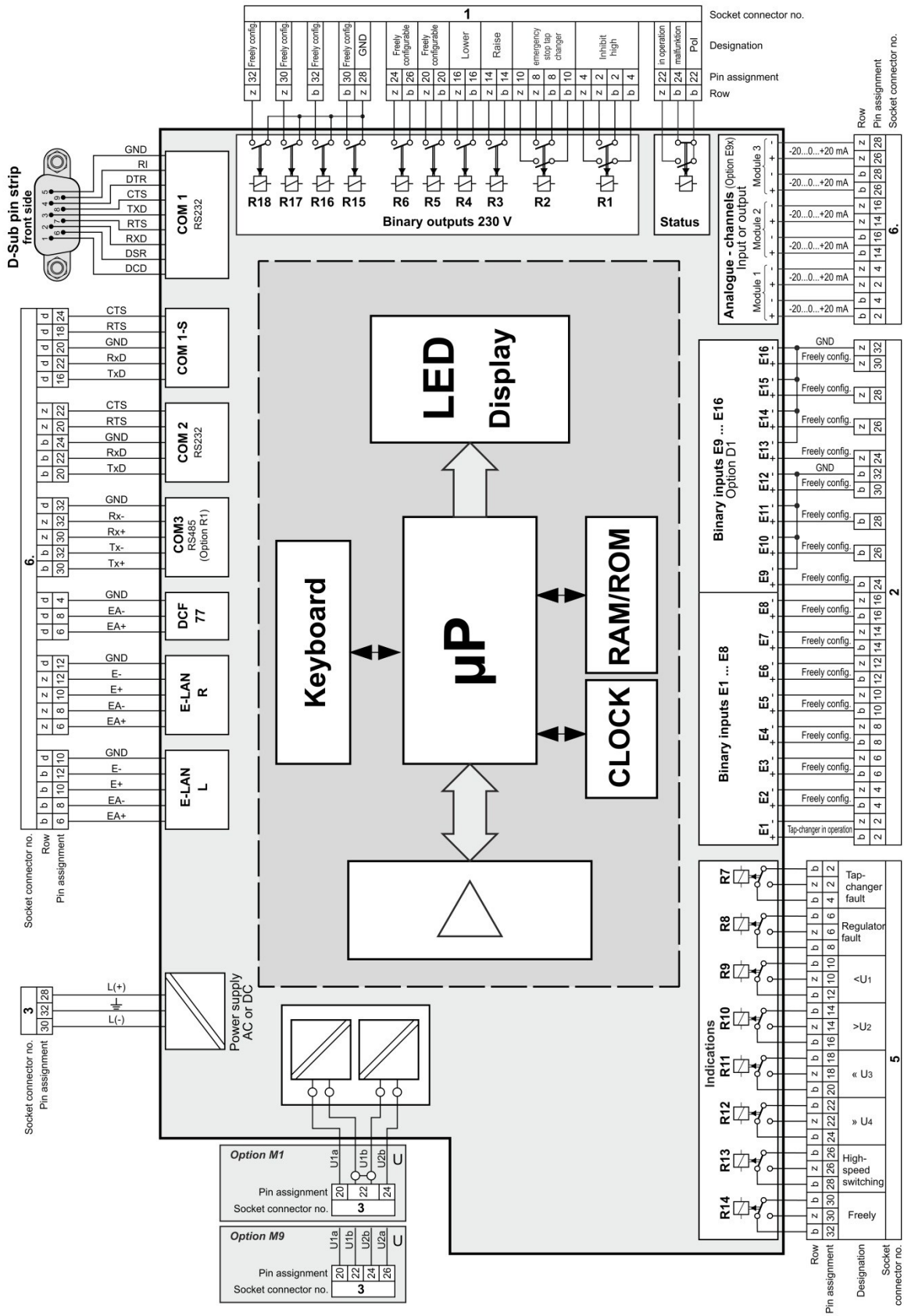

Block diagram PAN-D Characteristic D1

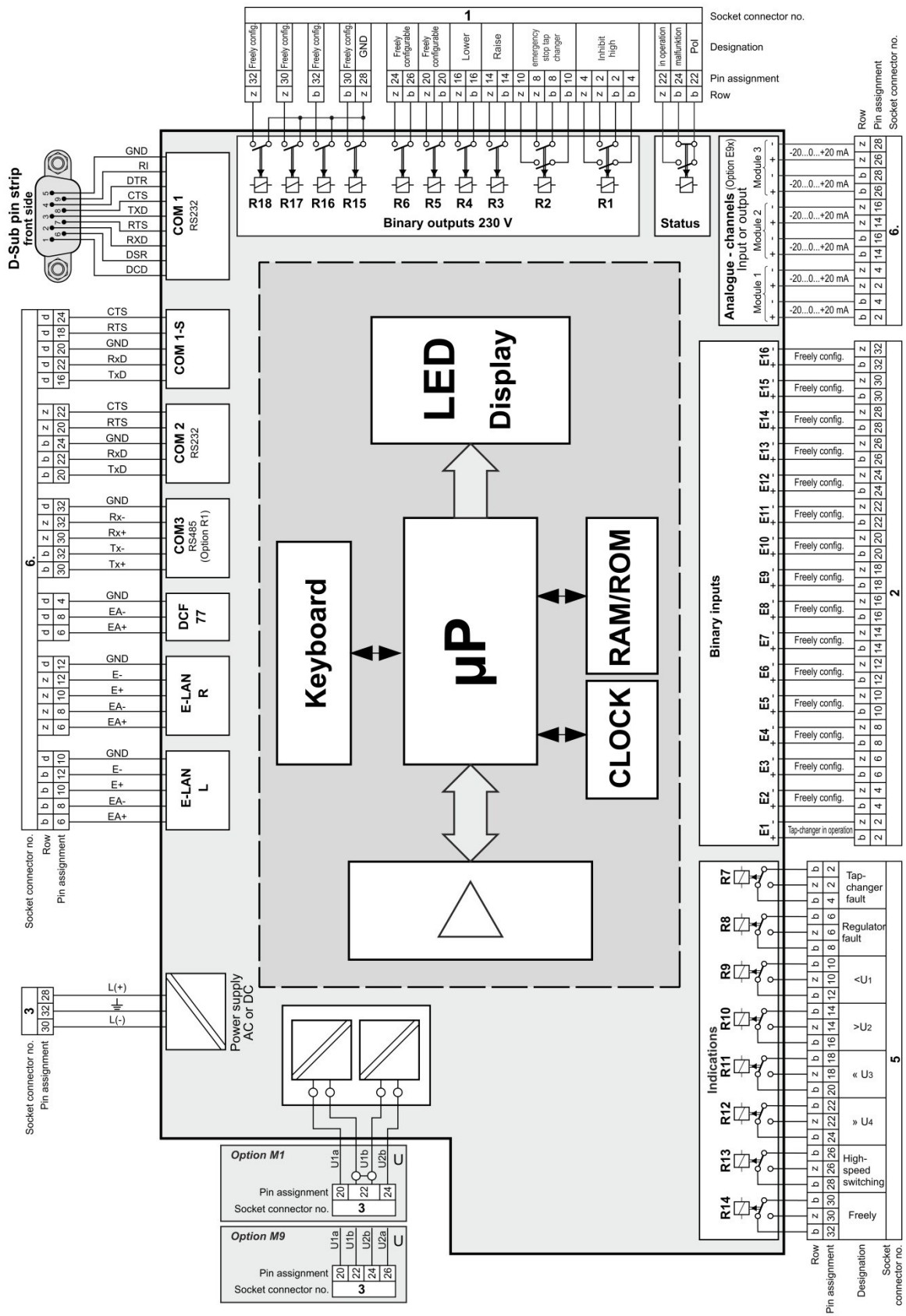

Block diagram PAN –D Characteristic D2 / D3 / D4 / D5

7. Housing technology

REGSys™ has a very flexible housing technology. A few of the housing configurations are described below. Most of the housings and 19" racks come with customer-specific wiring. The terminal configuration can be taken from the system-specific wiring diagrams. Please contact A. Eberle support if you do not have the diagrams.

7.1 19" card racks (19" rack)

Material	Aluminium
Protection type	IP 20
Weight	≤ 5 kg
Dimensions	see drawings
Width of the card rack	84 HP

Connection elements		Number of terminals
Characteristic B92	Screw terminals	max. 200
Characteristic B93	Phoenix pluggable screw terminals	160
Characteristic B95	Phoenix pluggable screw terminals	fixed allocation through backplane*

*the Phoenix pluggable screw terminals in the cover can be used for components without backplane (e.g. PAN-A1, PQI-D). The number of terminals depends on the assembly.

7.2 Panel/wall mounting housing

Material	Plastic
Protection type	Front panel IP 65
Weight	≤ 4 kg
Dimensions	see drawings
Housing width	30 or 49 HP

Connection elements		Number of terminals
Charact. B30 (30HP WMH short TB)	Phoenix pluggable screw terminals	26
Charact. B31 (30HP WMH long TB)	Phoenix pluggable screw terminals	42
Charact. B32 (30HP PMH)	Phoenix pluggable screw terminals	58
Charact. B33 (30HP PMH)	Cooper Bussmann screw terminals	68
Charact. B40 (49HP WMH short TB)	Phoenix pluggable screw terminals	58
Charact. B41 (49HP WMH long TB)	Phoenix pluggable screw terminals	90
Charact. B42 (49HP PMH)	Phoenix pluggable screw terminals	90
Charact. B43 (49HP PMH)	Cooper Bussmann screw terminals	88

WMH: Wall mounting housing

PMH: Panel mounting housing

short TB: short terminal box, long TB: long terminal box

* No. of terminals with standard wiring. Depending on the configuration it's possible that the real no. of terminals is different.

The conductor cross section and the maximum tightening torque of the different terminal types can be found in section 7.3.

7.3 Illustrations and dimensions of the modules and housings

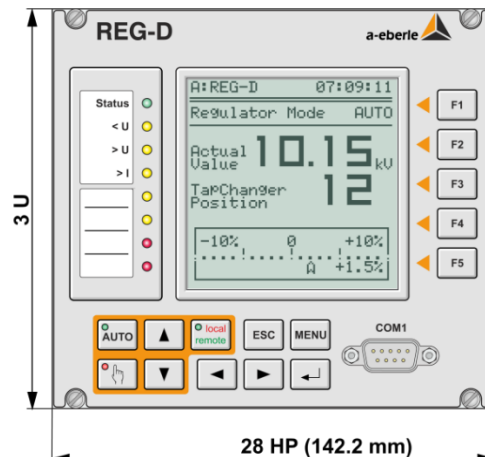
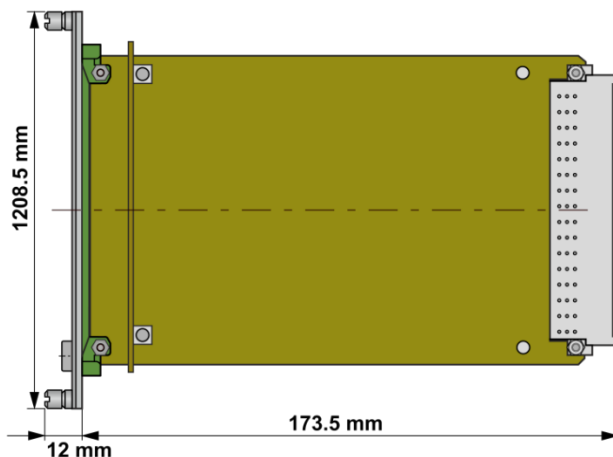

Plug-in module REG-D™/PAN-D 28 HP Characteristic B01

We take care of it.

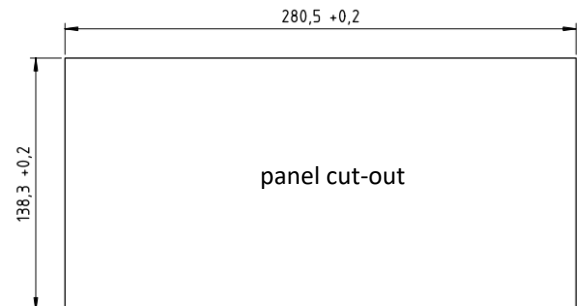
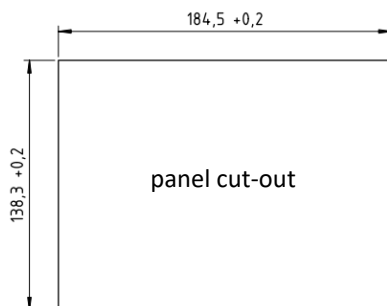
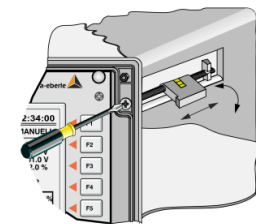
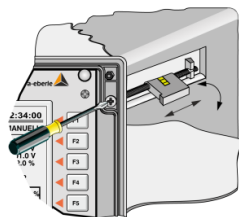
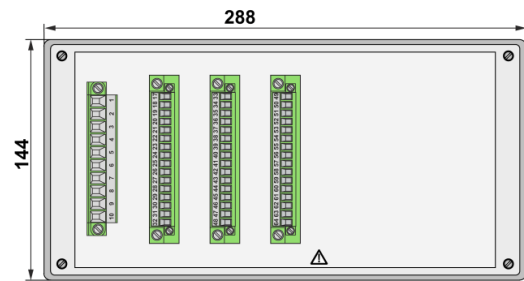
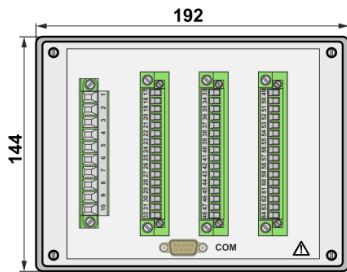
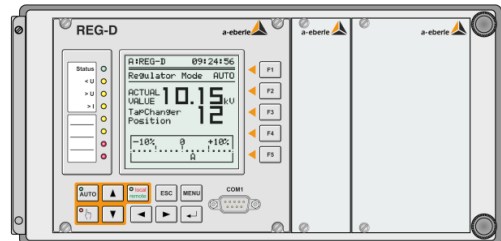
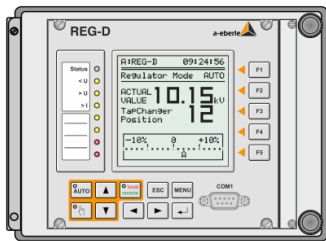
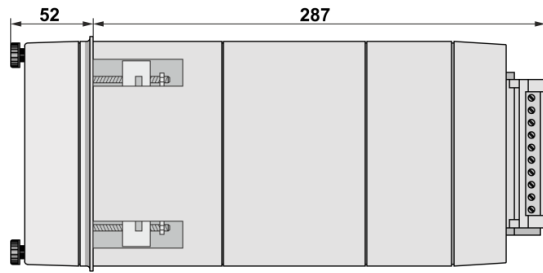

Conductor cross section and torque of the terminals			
connector, pitch, application example	cross section / mm ²		torque Nm
	stranded	solid	
10 poles, 7.62 mm, measurements , aux. voltage	4	4	0,6
16 poles, 5 mm, Bls, relays	2,5	2,5	0,6
4/5 poles, 3.81 mm, additional functions, COMs	1,5	1,5	0,25

Conductor cross section and torque of the terminals			
connector, pitch, application example	cross section / mm ²		torque Nm
	stranded	solid	
10 poles, 7.62 mm, measurements , aux. voltage	4	4	0,6
16 poles, 5 mm, Bls, relays	2,5	2,5	0,6
4/5 poles, 3.81 mm, additional functions, COMs	1,5	1,5	0,25

Panel mounting housing 30 HP - Characteristic B32
Dimensions in mm

Panel mounting housing 49 HP - Characteristic B42
Dimensions in mm

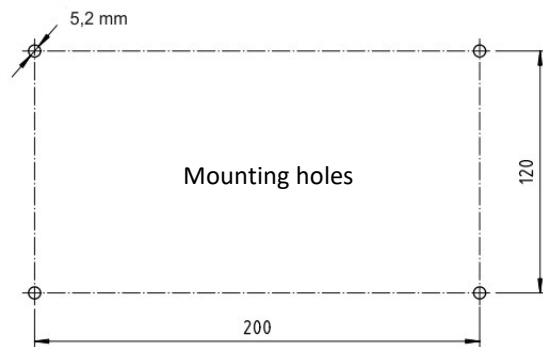
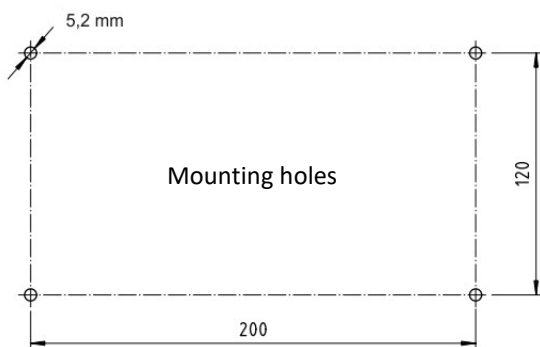
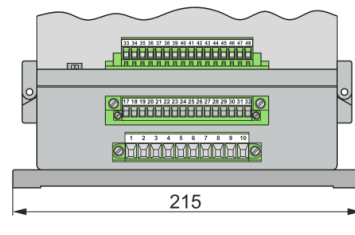
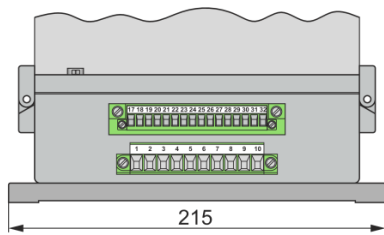
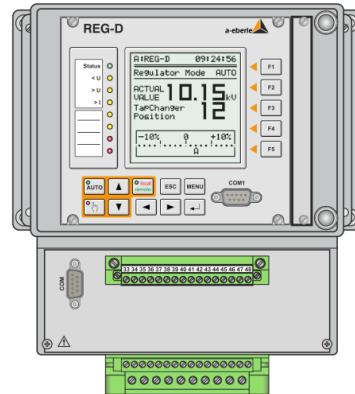
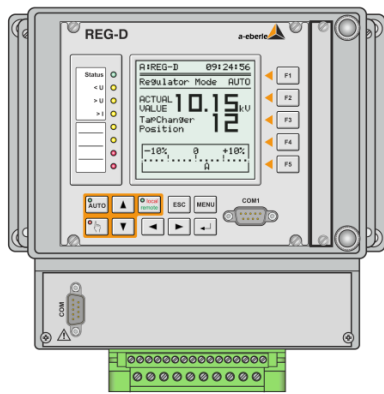
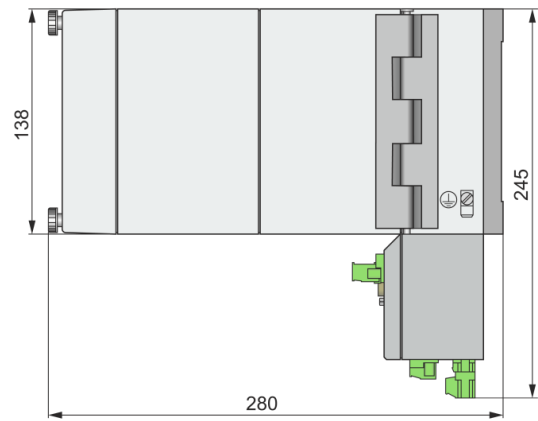
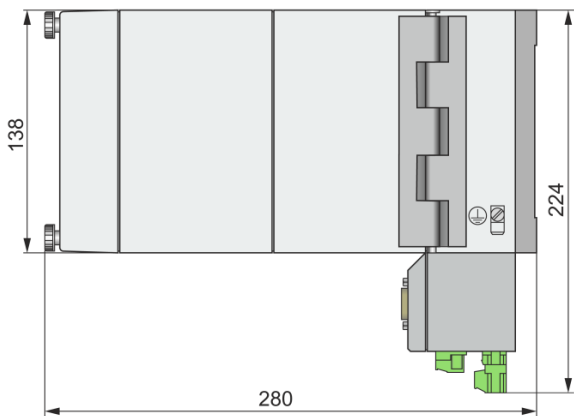

Conductor cross section and torque of the terminals			
connector, pitch, application example	cross section / mm ²		torque Nm
	stranded	solid	
10 poles, 7.62 mm, measurements, aux. voltage	4	4	0,6
16 poles, 5 mm, BIs, relays	2,5	2,5	0,6
4/5 poles, 3.81 mm, additional functions, COMs	1,5	1,5	0,25

Conductor cross section and torque of the terminals			
connector, pitch, application example	cross section / mm ²		torque Nm
	stranded	solid	
10 poles, 7.62 mm, measurements, aux. voltage	4	4	0,6
16 poles, 5 mm, BIs, relays	2,5	2,5	0,6
4/5 poles, 3.81 mm, additional functions, COMs	1,5	1,5	0,25

Wall mounting housing 30 HP short terminal box
Characteristic B30, Dimensions in mm

Wall mounting housing 30 HP long terminal box
Characteristic B31, Dimensions in mm

We take care of it.

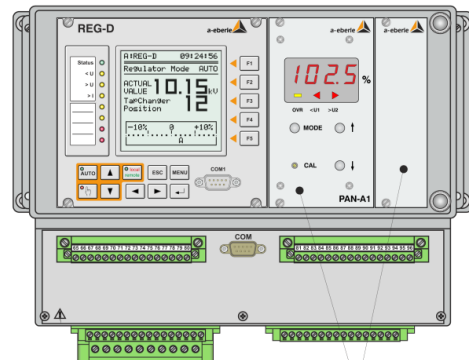
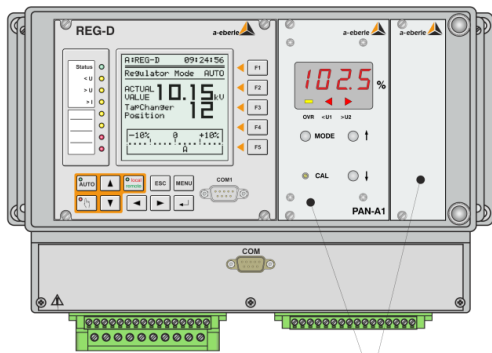
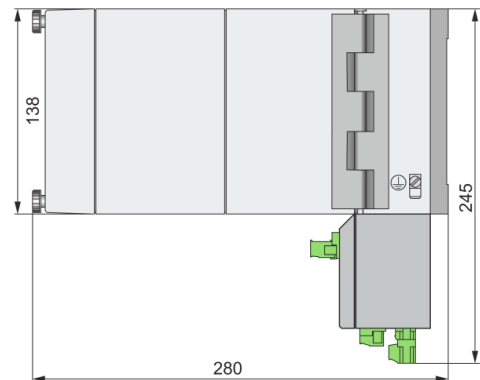
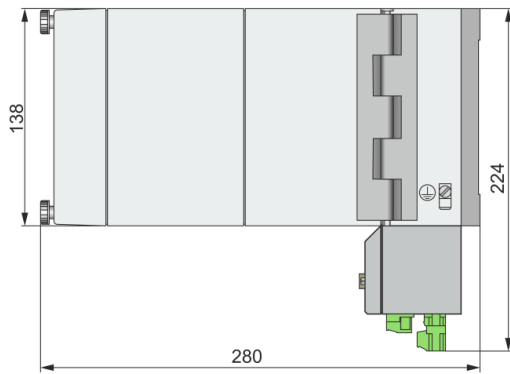

Note:
The housing can be supplied with additional equipment as well as applicationspecific pin assignment according to agreement

Note:
The housing can be supplied with additional equipment as well as applicationspecific pin assignment according to agreement

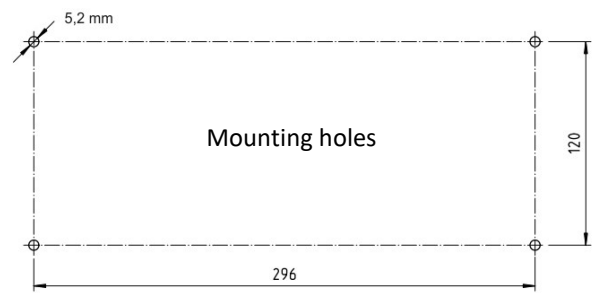
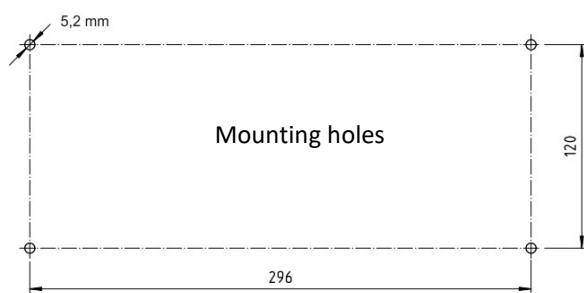
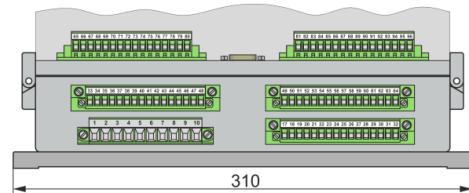
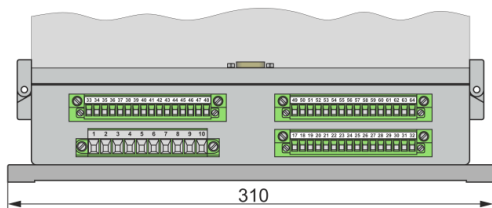

Conductor cross section and torque of the terminals			
connector, pitch, application example	cross section / mm ²		torque Nm
	stranded	solid	
10 poles, 7.62 mm, measurements , aux. voltage	4	4	0,6
16 poles, 5 mm, Bls, relays	2,5	2,5	0,6
4/5 poles, 3.81 mm, additional functions, COMs	1,5	1,5	0,25

Conductor cross section and torque of the terminals			
connector, pitch, application example	cross section / mm ²		torque Nm
	stranded	solid	
10 poles, 7.62 mm, measurements , aux. voltage	4	4	0,6
16 poles, 5 mm, Bls, relays	2,5	2,5	0,6
4/5 poles, 3.81 mm, additional functions, COMs	1,5	1,5	0,25

Wall mounting housing 49 HP short terminal box
Characteristic B40, Dimensions in mm

Wall mounting housing 49 HP long terminal box
Characteristic B41, Dimensions in mm

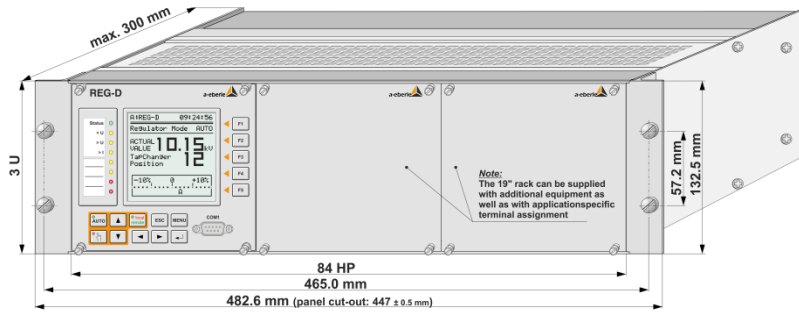

19" card rack 84 HP Front view - Characteristic B92/B93/B95

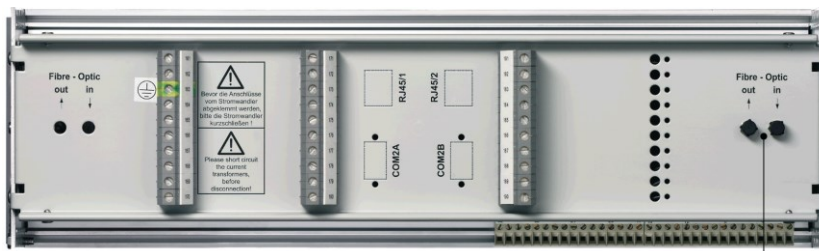

Fibre optic in-/output with ST or FSMA connector

Conductor cross section and torque of the terminals							
terminal type/terminal no.	cross section / mm ²		torque Nm	terminal type/terminal no.	cross section / mm ²		torque Nm
	stranded	solid			stranded	solid	
screw terminal element, 1...160	1,5	2,5	0,5	Feed-through terminal, 161 ... 200	4	6	0,8

19" card rack 84 HP Rear view with screw terminals - Characteristic B92

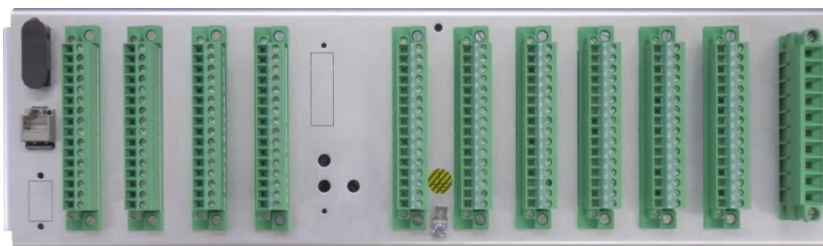

Conductor cross section and torque of the terminals							
connector, pitch, application example	cross section / mm ²		torque Nm	connector, pitch, application example	cross section / mm ²		torque Nm
	stranded	solid			stranded	solid	
10 poles, 7.62mm, measurement, aux. volt.	4	4	0,6	16 poles, 5mm, BIs, relays	2,5	2,5	0,6

19" card rack 84 HP with Phoenix pluggable screw terminals Rear view - Characteristic B93

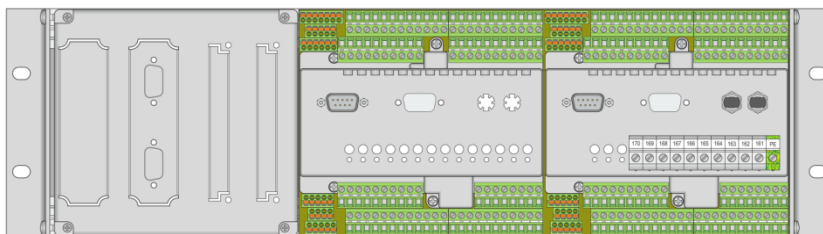

Conductor cross section and torque of the terminals							
terminal type, pitch, application example	cross section/mm ²		torque Nm	terminal type, pitch, appl. expl.	cross section / mm ²		torque Nm
	stranded	solid			stranded	solid	
Feed-through terminal, measurement, aux.	4	6	0,8	Pluggable screw terminal, 5mm, binary inputs (BIs), relays	2,5	2,5	0,6
Pluggable spring type terminal, 3.5mm, COMs	1,5	1,5	--				

19" card rack 84 HP with backplane Rear view - Characteristic B95

7.4 Backplane terminal configuration for REG-D™ (characteristic B95)



The below terminal configuration always applies to one device only (REG-D™ or PAN-D). If the MR is equipped with several devices, the terminal configuration will be identical for each device, but the terminal configuration numbers (-X1, -X2) will be different for each device.

	Description	No.	
U _H	PE	PE	
	L(+)	161	
	N(-)	162	
Voltage	U1a	163	
	U1b	164	
	U2a	**	
	U2b	**	
Current	I _{E1} S1	165	
	I _{E1} S2	166	
	I _{E2} S1	**	
	I _{E2} S2	**	
Binary inputs	BI 1 (+)	22	
	BI 2 (+)	21	
	GND BI 1...2 (-)	23	
	BI 3 (+)	20	
	BI 4 (+)	19	
	BI 5 (+)	17	
	BI 6 (+)	16	
	BI 7 (+)	15	
	BI 8 (+)	14	
	GND BI 3...8 (-)	18	
	BI 9 (+)	Characteristic D1	12
	BI 10 (+)		11
	BI 11 (+)		10
	BI 12 (+)	BI 9 (+)	9
	BI 9...12 (-)	BI 13 (+)	13
	BI 13 (+)	BI 10 (+)	2
	BI 13 (-)	BI 14 (+)	1
	BI 14 (+)	BI 11 (+)	4
	BI 14 (-)	BI 15 (+)	3
	BI 15 (+)	BI 12 (+)	6
BI 15 (-)	BI 16 (+)	5	
BI 16 (+)	GND BI 9...12 (-)	8	
BI 16 (-)	GND BI 13...16 (-)	7	
Binary outputs	Relay 1 (NOC)	66	
		65	
	Relay 1 (NCC)	64	
		63	
	Relay 2 (NOC)	70	
		69	
		68	
		68	

	Description	No.
	Relay 2 (NCC)	67
	Relay 3 (NOC)	43
		42
	Relay 4 (NOC)	45
		44
	Relay 5 (NOC)	47
		46
	Common Relay 6...9	28
	Relay 6 (NOC)	27
	Relay 7 (NOC)	25
	Relay 8 (NOC)	26
	Relay 9 (NOC)	24
	Manual/Auto common	31
	Manual (NCC)	29
	Auto (NOC)	30
	Status***	49
Status***	48	
E-LAN L	EA+	116
	EA-	115
	E+	114
	E-	113
	GND	117
E-LAN R	EA+	109
	EA-	108
	E+	107
	E-	106
	GND	110
COM1-S/4	COM1-S / COM 4	SUB-D
COM2****	COM2 TXD	97
	COM2 RXD	98
	COM2 GND	99
	COM2 RTS	96
	COM2 CTS	95
COM3	COM3 Tx+	89
	COM3 Tx-	88
	COM3 Rx+	86
	COM3 Rx-	87
	COM3 GND	90
Analogue Channels	Analogue Channel 1 (+)	105
	Analogue Channel 1 (-)	104
	Analogue Channel 2 (+)	103
	Analogue Channel 2 (-)	102
	Analogue Channel 3 (+)	101
	Analogue Channel 3 (-)	100
	Analogue Channel 4 (+)	112
	Analogue Channel 4 (-)	111
Analogue Channel 5 (+)	92	
Analogue Channel 5 (-)	91	
Analogue Channel 6 (+)	94	

	Description				No.
	Analogue Channel 6 (-)				93
Additional BIs, relays, SCADA interface (X01, X15, X24, X25, X28, X29, XW1)	X 15, 24, 28, 29	X25	X01	XW1	
	BI 17 (+)	BI 17 (+)	Rel 10 COM		80
	BI 17 (-)	BI 17 (-)	Rel 10 NOC	COM1 TxD	81
	BI 18 (+)	BI 18 (+)	Rel 10 NCC	COM1 GND	82
	BI 18 (-)	BI 18 (-)		COM1 RTS	77
	BI 19 (+)	BI 19 (+)	Rel 11 COM		83
	BI 19 (-)	BI 19 (-)	Rel 11 NOC		84
	BI 20 (+)	BI 20 (+)	Rel 11 NCC		85
	BI 20 (-)	BI 20 (-)			76
	BI 21 (+)	BI 21 (+)	Rel 12 COM		56
	BI 21 (-)	BI 21 (-)	Rel 12 NOC		57
	BI 22(+)	BI 22(+)	Rel 12 NCC		58
	BI 22 (-)	BI 22 (-)			75
	BI 23 (+)	BI 23 (+)	Rel 13 COM		59
	BI 23 (-)	BI 23 (-)	Rel 13 NOC		60
	BI 24 (+)	BI 24 (+)	Rel 13 NCC		61
	BI 24 (-)	BI 24 (-)			74
	BI 25 (+)		Rel 14 COM		73
	BI 25 (-)		Rel 14 NOC		72
	BI 26 (+)		Rel 14 NCC		71
	BI 26 (-)			RS485 P (A)*	41
	BI 27 (+)		Rel 15 COM	RS485 GND	40
	BI 27 (-)		Rel 15 NOC		39
	BI 28 (+)	BI 25 (+)	Rel 15 NCC		38
	BI 28 (-)	BI 29 (+)			55
	BI 29 (+)	BI 26 (+)	Rel 16 COM		37
	BI 29 (-)	BI 30 (+)	Rel 16 NOC		36
	BI 30 (+)	BI 27 (+)	Rel 16 NCC		35
	BI 30 (-)	BI 31 (+)			54

	Description				No.
	BI 31 (+)	BI 28 (+)	Rel 17 COM		34
	BI 31 (-)	BI 32 (+)	Rel 17 NOC		32
	BI 32 (+)	BI 25..28 (-)	Rel 17 NCC		53
	BI 32 (-)	BI 29..32 (-)			33
				COM1 RxD	79
				COM1 CTS	78
				RS485 N (B)	62

** customer-specific wiring for characteristics M2, M3 and M9
 *** based on characteristic U, the status contact is either NOC or NCC
 **** COM2 can only be used without SCADA interface installed

7.5 Backplane terminal configuration for PAN-D (characteristic B95)

	Description		No.	
U _H	PE		PE	
	L(+)		161	
	N(-)		162	
Voltage	U1a (L1)		163	
	U1b (L2)		164	
	U2a		*	
	U2b (L3)		165*	
Binary inputs	BI 1 (+)		22	
	BI 2 (+)		21	
	GND BI 1...2 (-)		23	
	BI 3 (+)		20	
	BI 4 (+)		19	
	BI 5 (+)		17	
	BI 6 (+)		16	
	BI 7 (+)		15	
	BI 8 (+)		14	
	GND BI 3...8 (-)		18	
	BI 9 (+)		Characteristic D1	12
	BI 10 (+)			11
	BI 11 (+)			10
	BI 12 (+)		BI 9 (+)	9
	BI 9...12 (-)		BI 13 (+)	13
	BI 13 (+)		BI 10 (+)	2
	BI 13 (-)		BI 14 (+)	1
	BI 14 (+)		BI 11 (+)	4
	BI 14 (-)		BI 15 (+)	3
	BI 15 (+)		BI 12 (+)	6
BI 15 (-)		BI 16 (+)	5	
BI 16 (+)		GND BI 9...12 (-)	8	
BI 16 (-)		GND BI 13...16 (-)	7	

		Description	No.
Binary outputs	Relay 1 (triggered by circuit breaker) NOC		66
			65
	Relay 1 (triggered by circuit breaker) NOC		64
			63
	Relay 2 (Emergency OFF tap changer) NOC		70
			69
	Relay 2 (Emergency OFF tap changer) NOC		68
			67
	Relay 3 (increase interlock) NOC		43
			42
	Relay 4 (decrease interlock) NOC		45
			44
	Relay 5 (freely programmable) NOC		47
			46
	Status common		31
	Status NCC (closes upon failure)		29
	Status NOC (opens upon failure)		30
	Relay 7 (tap changer failure) Common		80
	Relay 7 (tap changer failure) NOC		81
	Relay 7 (tap changer failure) NCC		82
	Relay 8 (regulator failure) Common		83
	Relay 8 (regulator failure) NOC		84
	Relay 8 (regulator failure) NCC		85
	Relay 9 (<U1) Common		56
	Relay 9 (<U1) NOC		57
	Relay 9 (<U1) NCC		58
	Relay 10 (>U2) Common		59
	Relay 10 (>U2) NOC		60
	Relay 10 (>U2) NCC		61
	Relay 11 (<<U3) Common		73
	Relay 11 (<<U3) NOC		72
	Relay 11 (<<U3) NCC		71
	Relay 12 (>>U4) Common		40
	Relay 12 (>>U4) NOC		39
	Relay 12 (>>U4) NCC		38
	Relay 13 (fast circuit switching) Common		37
	Relay 13 (fast circuit switching) NOC		36
	Relay 13 (fast circuit switching) NCC		35
	Relay 14 (freely programmable) Common		34
	Relay 14 (freely programmable) NOC		32
Relay 14 (freely programmable) NCC		53	
Common Relay 15...18		28	
Relay 15 (NOC)		27	
Relay 16 (NOC)		25	
Relay 17 (NOC)		26	
Relay 18 (NOC)		24	

E-LAN L	EA+	116
	EA-	115
	E+	114
	E-	113
	GND	117

		Description	No.
E-LAN R	EA+	109	
	EA-	108	
	E+	107	
	E-	106	
	GND	110	
COM1-S	COM1-S	SUB-D	
COM2**	COM2 TXD	97	
	COM2 RXD	98	
	COM2 GND	99	
	COM2 RTS	96	
	COM2 CTS	95	
COM3	COM3 Tx+	89	
	COM3 Tx-	88	
	COM3 Rx+	86	
	COM3 Rx-	87	
	COM3 GND	90	
Analogue Channels	Analogue Channel 1 (+)	105	
	Analogue Channel 1 (-)	104	
	Analogue Channel 2 (+)	103	
	Analogue Channel 2 (-)	102	
	Analogue Channel 3 (+)	101	
	Analogue Channel 3 (-)	100	
	Analogue Channel 4 (+)	112	
	Analogue Channel 4 (-)	111	
	Analogue Channel 5 (+)	92	
	Analogue Channel 5 (-)	91	
	Analogue Channel 6 (+)	94	
	Analogue Channel 6 (-)	93	

* customer-specific wiring for characteristic M9

** COM2 can only be used without SCADA interface installed

REGSys™ - Overview

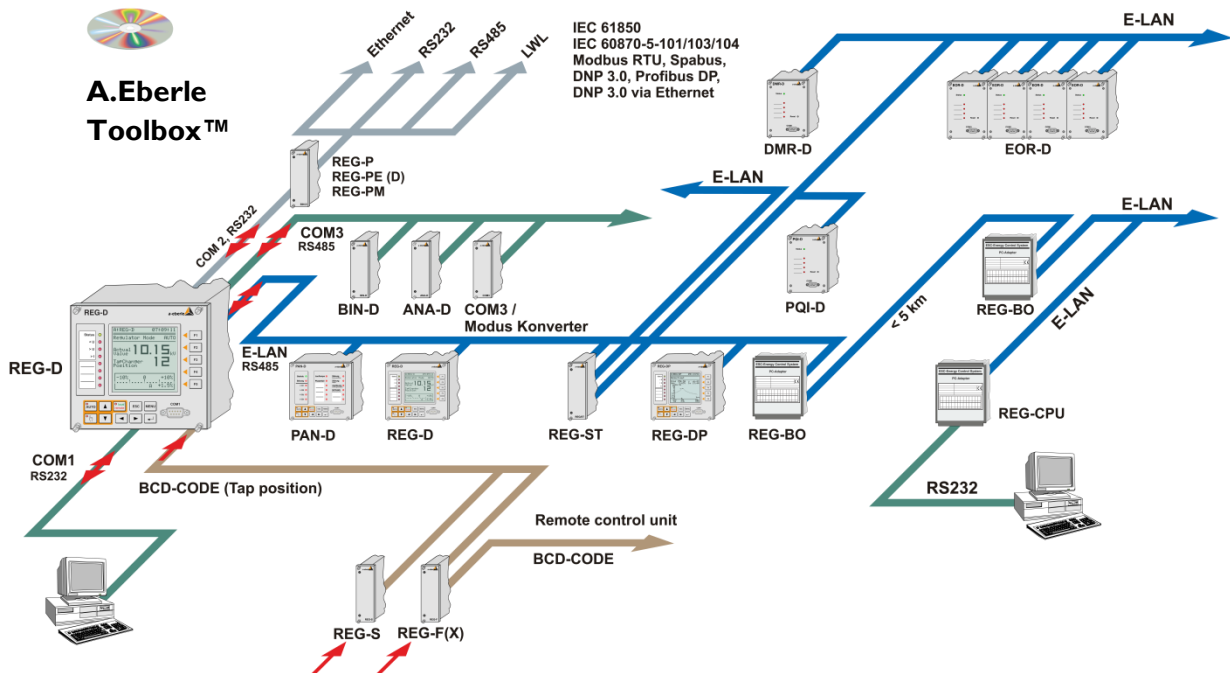

8. Interfaces and software

Several regulators need to be interconnected in a network when transformers are connected in parallel. The $\Delta I \cdot \sin \phi$, $\Delta I \cdot \sin \phi (S)$ and Master-Follower parallel programs can only be implemented through the system bus (E-LAN). This bus enables each of the members in a group of parallel regulators to communicate with each other easily, without using any additional components.

The regulators do not have to be connected in order to run a parallel program that functions in accordance to the $\Delta \cos \phi$ method. It may not be possible to connect the participants due to the long distances between them, for example.

If an interconnection needs to be established over long distances, the E-LAN can be redirected through a fibre optic cable or an Ethernet connection.

8.1 Serial interfaces

The REG-D™ and the PAN-D have two RS232 serial interfaces with three connections (COM1, COM1-S, COM2). COM1 is the parameterisation interface, while COM1-S is an alternative connection option for COM1. COM1 has priority, meaning that when COM1 has a connection, COM1-S is switched off. Devices connected to COM1-S do not have to be physically disconnected. This enables COM1-S to function as an alternative remote parameterisation interface that is only active when parameters are not being set locally. On devices with characteristic S2 it's possible to switch the COM1-S interface into a permanently working COM interface

(COM4). COM1 can also be configured as a USB port (optional).

COM2 is mainly used to connect the regulator to the SCADA system. If a SACDA interface is not installed, COM2 in the terminal compartment can be used to connect a modem, a COM server, a PC or a DCF77 receiver.

Connection elements

COM1	Sub-D 9-pole male (optionally as mini USB) at the front of the device
COM1-S / COM 4 (COM1-S is switched off when COM1 is used)	Male multipoint connector (printed circuit board VI) depends on the housing
COM2 / COM5	Male multipoint connector (printed circuit board VI) depends on the housing
Connection options	PC, modem, PLC, SCADA connection module, DCF77 signal
Number of data bits/protocol	Data bits: 8 Parity: even, none

We take care of it.

Transmission rate bit/s	1200, 2400, 4800, 9600, 19200, 38400, 57600, 115200, 230400*, 460800*, 921600*
HANDSHAKE	RTS / CTS, XON / XOFF, delay, none

* Only available on REG-D™ with characteristic S2 on COM1 and COM2

ELAN (Energy - Local Area Network)

Each REG-D™ regulator comes with two ELAN interfaces that are used to connect individual regulators and monitoring units to a voltage regulation system.

ELAN characteristics

- 255 addressable participants
- Multi-master structure
- Integrated repeater function
- Open ring, bus or point-to-point connection possible
- Transmission rate 15.6 ... 375 kbit/s

COM3 (peripheral interface)

The COM3 is an RS485 or optional fibre optic interface used to connect up to 16 interface modules (BIN-D, ANA-D) in any combination to a REG-D or PAN-D. A COM3/Modbus converter can also be selected, in order to establish direct serial communication with other Modbus devices. This enables the REGSys™ to acquire values such as the winding temperature or the gas-in-oil ratio from other devices and transmit them to the SCADA or record them in Recorder mode.

Time Synchronisation

A time synchronisation input enables the time on the REG-D or PAN-D to be synchronised using a DCF77 signal. This input is designed for an RS485 (5 V) signal and can be wired as a time synchronisation bus to several devices. The termination (terminating resistor) can be switched on and off by using jumpers on the CPU board.

If a DCF signal cannot be received, a GPS clock or controller card that emulates a DCF signal can be used. Time can also be synchronised through SCADA.

Time synchronisation input is not supported until firmware version 2.22.

8.2 A.Eberle Toolbox™ - Parameterisation and configuration software

The software A.Eberle Toolbox™ (AET) is used to parameterise and program the system. The following functions are available:

- Device management (project)
- Parameterisation incl. transformer monitoring, background programs and features
- Readout and visualisation of recorder and statistics data.
- HMI for visualising the REG-DA front panel
- Terminal programme for direct communication with the REG-DA
- Firmware update

Communication with the device can be established via a serial interface or network-based (COMserver).

The AET runs on the following operating systems:

- Windows 10
- Windows Server from 2012 onwards

Most of the settings can be made either directly on the regulator using the regulator's membrane keyboard, or centrally through AET. If the device is to be accessed through a central point, all of the regulators must be connected to each other through the E-LAN.

The SCADA interface card is set up with the software WinConfig.

REG-D™ parameters (selection)

Parameter	Setting range
Permissible (voltage) deviation	± 0.1 ... 10 % ± 0.1 ... 100 % for P/Q regulation
Time factor	0.1 ... 30
Setpoint value 1..2	60.0 ... 140.0 V
Setpoint value 3..4	60.0 ... 140.0 V or -500 ... 500 % for P/Q regulation
Time behaviour	$\Delta U \cdot t = \text{const}$ REG 5A/E LINEAR CONST
Trend memory	0 ... 60 s
Current influence (load-dependent setpoint)	Apparent current Active current Reactive current LDC
Apparent, active, reactive current	
Increase (I) (pos.)	0 ... 400 V/In
Increase (I) (neg.)	0 ... 400 V/In
Limit (I) (max.)	-40 ... 40 V
Limit (I) (min.)	-40 ... 40 V
LDC (Line drop compensation)	R : 0 ... ± 100 Ω X : 0 ... ± 100 Ω
Undervoltage <U	-25 % ... +10 %
Overvoltage >U	0 ... 25 %
Overcurrent >I	0 ... 210 % (1A / 5A)
Undercurrent >I	0 ... 100 % (1A / 5A)
Inhibit High	65 V ... 150 V
Fast switching forward	0 ... -35 %
Fast switching backward	0 ... 35 %
Inhibit low	-75 % ... 0 %
Switching delay for <U, >U, <I, Inhibit high, Fast switching, Inhibit low can be set separately	1 ... 999 s (Fast step-up 2...999 s)
Parallel programs	dI*sin(phi) dI*sin(phi)[S] dCos (phi) Master-Follower MSI MSI2
TC in operation - maximum time*	3 ... 40 s

PAN-D parameters (selection)

Parameter	Setting range
Undervoltage <U ₁	-25 ... 10 %
Overvoltage >U ₂	0 ... 25 %
Undervoltage «U ₃	-35 ... 10 %
Overvoltage »U ₄	0 ... 35 %
Inhibit high	65 V ... 150 V
Switching delay for <U ₁ , >U ₂ , «U ₃ , »U ₄ , Inhibit high (independent setting for each limit)	1 ... 999 s
TC in operation - maximum time*	3 ... 40 s

*when a PAN-D is available, the TC in operation signal is monitored by the PAN-D.

8.3 REGSim™ simulation software

REGSim™ was designed to simulate the parallel connection of several transformers in any network and load configuration, and to show the results on a PC.

To ensure that the REG-D™ produces the same results during the simulation as in a live environment, the transformers, the network and the load are accurately recreated mathematically.

The authenticity of the simulation is guaranteed because REGSim™ uses the REG-D™ relay's original algorithm.

All of the settings match those of the real regulator and the simulation is run in real time.

REGSim™ enables parameters to be tested and set before using them in a live environment.

9. Order specifications

- Only one code of the same capital letter is possible
- When the capital letter is followed by number 9, further details may be necessary
- The code can be omitted when the capital letter is followed by zero or one option is marked as standard

CHARACTERISTIC	CODE	
	Design	
30 HP housing		
Wall mounting housing with short terminal box (30HP) with Phoenix pluggable screw terminals		B30
Wall mounting housing with long terminal box (30HP) with Phoenix pluggable screw terminals		B31
Panel mounting housing (30HP) with Phoenix pluggable screw terminals		B32
Panel mounting housing (30HP) special design with Cooper Bussmann screw terminals		B33
49 HP housing		
Wall mounting housing with short terminal box (49HP) with Phoenix pluggable screw terminals		B40
Wall mounting housing with long terminal box (49HP) with Phoenix pluggable screw terminals		B41
Panel mounting housing (49HP) with Phoenix pluggable screw terminals		B42
Panel mounting housing (49HP) special design with Cooper Bussmann screw terminals		B43
19" card racks (84HP)		
19" card rack (84HP) with wire-wrap wiring and screw terminals		B92
19" card rack (84HP) with Phoenix pluggable screw terminals		B93
19" card rack (84HP) with backplane		B95

CHARACTERISTIC	CODE	
	REG-D™	PAN-D
REG-D™ Relay for Voltage Control & Transformer Monitoring	REG-D™	
Plug-in module 28 HP, 3 U basic configuration with dual ELAN interface, COM1, COM2, 16 binary inputs, 10 relay outputs and status relays and parameterisation and programming software incl. connection cable		
PAN-D Monitoring unit		PAN-D
Plug-in module 28 HP, 3 U basic configuration with dual ELAN interface, COM1, COM2, 16 binary inputs, 14 relay outputs and status relays		
Design		
● Plug-in unit	B01	B01
Power supply		
● from the measuring circuit AC 80 V ... <u>110 V</u> ... 185 V	H0	H0
● external AC 100 V ... <u>110 V</u> ... 240 V / DC 100 V ... 220 V ... 300 V	H1	H1
● external AC 100 V ... 110 V ... 240 V / DC 100 V ... 220 V ... 300 V, 20 Watt	H11	-
● external DC 20 V ... <u>60 V</u> ... 70 V	H2	H2
Note: H0/H1 for REG-P(E) with FO please use a REG-NTZ. H11 is meant for REG-P(E) with FO but without REG-NTZ. H2 for REG-P(E) with FO please use a REG-NTZ.		

CHARACTERISTIC	CODE	
	REG-D™	PAN-D
COM1 serial interface in the front panel <ul style="list-style-type: none"> ● RS232 with SUB-D connector (9-pin male), standard if characteristic I is not specified ● USB (Mini-USB connector) 	I0 I1	I0 I1
Input current (can be changed at a later stage) <ul style="list-style-type: none"> ● I_{EN} 1A ● I_{EN} 5A 	F1 F2	- -
Voltage and current measurement <ul style="list-style-type: none"> ● Three-wire three-phase system with balanced load (1 x voltage, 1 x current) ● Three-wire three-phase system, three-phase voltage measurement only ● Three-wire three-phase system with unbalanced load (ARON connection) ● U measurement high voltage, U and I measurement low voltage side ● other application with 2 x CT's and 2 x VT's; Feature for three winding transformers always active (deactivation possible) 	M1 - M2 M3 M9	- M1 - - M9
Recorder function for quantities U, I, P, Q, S, PF, tap position incl. REGView visualisation software <ul style="list-style-type: none"> ● without ● with max. 3 channels ● with max. 256 channels (4 x 64) and 108 MB internal memory and upgraded CPU, including S1 <p>Note: If Sampled Values (IEC 61850-9-2LE) are used the feature S2 is mandatory!</p>	S0 S1 S2	S0 S1 -
Parallel operation <ul style="list-style-type: none"> ● Parallel operation: without ● Parallel operation: with (incl. ParaGramer) ● Feature K1 and additional HVLVControl ● Feature K1 and additional Crosslink ● Feature K1 and additional Crosslink & HVLV ● Feature K1 and additional Ringlink ● Feature K1 and additional Ringlink & HVLVControl 	K0 K1 K2 K3 K4 K5 K6	- - - - - - -
PQCtrl – Feature for regulating active or reactive power <ul style="list-style-type: none"> ● PQCtrl: without ● PQCtrl: with 	P0 P1	- -
Transformer monitoring according to IEC 60354 or IEC 60076 <ul style="list-style-type: none"> ● Transformer monitoring according to IEC 60354 or IEC 60076: without ● Transformer monitoring according to IEC 60354 or IEC 60076: with ● Transformer monitoring according to IEC 60354 or IEC 60076: with extended function: moisture in paper/oil, bubbling temperature (TM1 incl.) <p>Note: TM2 only possible with S2. Please choose from the feature group "E" an additional mA input module or select a PT-100 module for temperature measurement.</p>	TM0 TM1 TM2	- - -

Analogue in- and outputs			
<ul style="list-style-type: none"> ● without ● 2 x mA-inputs ● 4 x mA-inputs ● 6 x mA-inputs ● 2 x mA-outputs ● 4 x mA-outputs ● 6 x mA-outputs ● 2 x mA-inputs and 2 x mA-outputs ● 2 x mA-inputs and 4 x mA-outputs ● <u>4 x mA-inputs and 2 x mA-outputs</u> 	<p>Note: Please specify scaling if known: Example: Channel 1: -100 ... 0 ... + 100 mV -20 ... 0 ... + 20 mA Channel 2: 0 ... 80 ... 100 V 4 ... 16 ... 20 mA Channel 3: 1 ... 19 taps 0 ... 20 mA</p>	E00	E00
		E91	E91
		E92	E92
		E93	E93
		E94	E94
		E95	E95
		E96	E96
		E97	E97
		E98	E98
		<u>E99</u>	<u>E99</u>
<ul style="list-style-type: none"> ● 1 x PT100 input (three-wire connection) (slot 1) ● 1 x PT100 input (three-wire connection) (slot 2) ● 1 x PT100 input (three-wire connection) (slot 3) ● 2 x mA-inputs and 1 resistor module R1 (180Ω...2kΩ, min. 5Ω / step) ● 1 x PT 100 input and 1 x resistor module R1 (180Ω...2kΩ, min. 5Ω / step) ● 2 x mA-outputs and 1 x resistor module R1 (180Ω...2kΩ, min. 5Ω / step) ● 1 x resistor module R1 (180Ω...2kΩ, min. 5Ω / step) (slot 2) ● 2 x mA-inputs and 1 x PT 100 input ● 1 x PT 100 input and 1 x resistor module R3 (2kΩ...20kΩ, min. 50Ω / step) ● <u>3 x PT100 inputs</u> 		E901	E901
		E902	E902
		E903	E903
		E900.1	-
		E900.2	-
		E900.3	-
		E900.4	-
		E900.5	E900.5
		E900.6	-
		<u>E900.7</u>	<u>E900.7</u>
		E900.9	-
		E900.10	E900.10
		E900.11	E900.11
		E900.12	-
		E900.13	-
		E900.14	-
		E900.15	-
		E900.16	E900.16
		E900.17	-
		<u>E900.18</u>	-
		E900.19	-
		E900.20	E900.20
		E900.21	-
		E900.22	E900.22
		E900.23	-
		E900.24	-
		E900.25	E900.25
		E900.26	-
		E900.27	E900.27
		<u>E900.28</u>	-
		E900.29	E900.29
		E900.30	-
		E900.31	-
		E900.32	-
		E900.33	-
		E900.34	E900.34
		E900.35	E900.35
		E900.36	-
		E900.37	-
		<u>E900.38</u>	<u>E900.38</u>
		E900.39	E900.39
<ul style="list-style-type: none"> ● 2 x mA-inputs and 1 x PT 100 input and 2 x mA-inputs 		E900.40	E900.40

CHARACTERISTIC	CODE	
	REG-D™	PAN-D
<ul style="list-style-type: none"> any combination on request, 2 analogue inputs and outputs each, PT100 direct input, resistance measurement input (tap position potentiometer) <p>Note: A total of three modules can be used. This is particularly important when the transformer monitoring module is used! The underlined entries are just marked because of the readability, it's not any kind of preselection!</p>	E900	E900
<p>Binary inputs (freely programmable)</p> <ul style="list-style-type: none"> 8 x AC/DC 48...250V (BI1...BI8) and 8 x AC/DC 10...50V (BI9...BI16) 7 x AC/DC 48 ... 250V (BI2...BI8) and 9 x AC/DC 10 ... 50V (BI1, BI9...BI16) 16 x AC/DC 48...250 V (BI1...BI16) 16 x AC/DC 10...50V (BI1...BI16) 16 x AC/DC 80...250V (BI1...BI16) 16 x AC/DC 190...250V (BI1...BI16) 	D1 - D2 D3 D4 D5	D1 D1.1 D2 D3 D4 D5
<p>Additional inputs and outputs (freely programmable), not in combination with XW1</p> <ul style="list-style-type: none"> without 8 relays (changeover contacts) (BO10...BO17) 16 x AC/DC 48...250V (BI17...BI32) 16 x AC/DC 10...50V (BI17...BI32) 8 x AC/DC 48...250V (BI17...BI24), 8 x AC/DC 10..50V (BI25...BI32)" 16 x AC/DC 190...250V (BI17...BI32) 16 x AC/DC 80...250V (BI17...BI32) 	X00 X01 X15 X24 X25 X28 X29	- - - - - - -
<p>COM3 interface</p> <ul style="list-style-type: none"> without with RS485 <p>Note: COM3 is needed for ANA-D, BIN-D and COM3/Modbus converter! If a fibre optic connection for the COM3 is needed, please select the according feature of the housing or rack or specify it with additional text on the order</p>	R0 R1	R0 R1
<p>SCADA connection: internal or external</p> <ul style="list-style-type: none"> without (continue with characteristics group 'Y') with internal protocol interface (continue with characteristic group 'XL'), only with characteristic X00 with external protocol interface: REG-P/-PE/-PED^{SV} (continue with characteristic group 'Y') 	XW0 XW1 XW9	XW0 XW1 XW9
<p>Integrated protocol interface card</p> <ul style="list-style-type: none"> to connect one REG-D™ to SCADA to connect several systems to SCADA <p>Note: XL9 can only be combined with XZ01, XZ15...XZ19, XZ91</p>	XL1 XL9	- -
<p>Connection type</p> <ul style="list-style-type: none"> Copper conductors <ul style="list-style-type: none"> RS232 RS485 2-wire operation only Fibre optic cable with FSMA connection technology <ul style="list-style-type: none"> Fibreglass (Wave length 800...900 nm, range 2000 m) All-plastic (Wave length 620...680 nm, range 50 m) Fibre optic cable with ST connection technology <ul style="list-style-type: none"> Fibreglass (Wave length 800...900 nm, range 2000 m) 	XV10 XV11 XV13 XV15 XV17	- - - - -

CHARACTERISTIC	CODE	
	REG-D™	PAN-D
Protocol <ul style="list-style-type: none"> ● IEC60870-5-103 Standard ● IEC60870-5-103 for ABB ● IEC60870-5-103 for SAT ● IEC60870-5-103 for Siemens (LSA/SAS) ● IEC60870-5-103 for Sprecher Automation ● IEC60870-5-103 for others ● IEC60870-5-101 Standard ● IEC60870-5-101 for ABB ● IEC60870-5-101 for IDS ● IEC60870-5-101 for SAT ● IEC60870-5-101 for Siemens (LSA/SAS) ● IEC60870-5-101 for others ● DNP 3.00 ● SPABUS ● MODBUS RTU 	XZ03 XZ10 XZ12 XZ13 XZ14 XZ90 XZ01 XZ15 XZ17 XZ18 XZ19 XZ91 XZ20 XZ22 XZ23	- - - - - - - - - - - - - - -
Local/Remote control via keyboard (local/remote key) <ul style="list-style-type: none"> ● without ● with 	Y0 Y1	- -
Status contact <ul style="list-style-type: none"> ● closes in case of malfunction (NC contact) ● opens in case of malfunction (NO contact) 	U0 U1	- -
Operating instructions <ul style="list-style-type: none"> ● German ● English ● other on request 	G1 G2 G10	G1 G2 -
Display language <ul style="list-style-type: none"> ● German ● English ● French ● Spanish ● Italian ● Russian ● Portuguese ● Czech ● Dutch ● Polish 	A1 A2 A3 A4 A5 A6 A7 A8 A9 A10	- - - - - - - - -

REGSys™ Accessories	ID-No.
Rack design:	
Female multipoint connector 1 (Electrical connector block, model F, wire wrap)	582.0197
Female multipoint connector 1 (Electrical connector block, model F, 2.8 FASTON, 32 pins)	582.0213.01
Female multipoint connector 1 (Electrical connector block, model F, 2.8 FASTON, 48 pins)	582.0213
Female multipoint connector 2 (Current input with advanced contacts, 2 pole)	582.0258.10
Female multipoint connector 4 (Current input with advanced contacts, 6 pole)	582.0258.20
Female multipoint connector 3 (Mixed connector model F24 + H7, wire wrap)	582.0215
Female multipoint connector 3 (Mixed connector model F16 + H7, 6.3/2.8 FASTON)	582.0214
Female multipoint connector 3 (Mixed connector model F24 + H7, 6.3/2.8 FASTON)	582.0217
panel plate 28 HP	566.0028
panel plate 18 HP	566.0018
panel plate 14 HP	566.0014
panel plate 10 HP	566.0010
panel plate 8 HP	566.0008
panel plate 7 HP	566.0007
panel plate 6 HP	566.0006
panel plate 5 HP	566.0005
panel plate 4 HP	566.0004
panel plate 2 HP	566.0002
Fuses, batteries:	
1 pack microfuses T1 L 250 V, 1 A, for auxiliary voltage range H0 and H1	582.1002
1 pack microfuses T2 L 250 V, 2 A, for auxiliary voltage range H2	582.1019
1 lithium battery (pluggable)	570.0003.00
1 lithium battery (solderable)	570.0001
1 button cell CR1632	570.0005
Connection technique:	
Connection adapter set from fibre optic connector LC to ST including 1m fibre	111.9048.99
PC connection cable (null-modem cable)	582.020B
Modem connection cable	582.2040
RS232 10 m extension cable	582.2040.10
USB/RS232 adapter with integrated null-modem cable (FTDI), 1,5m	111.9046.01
Interface E-LAN-FO: RS485/FO, Fiber optics: multi-mode, max. transmission distance: 2.5 km, FO-connector: ST (E-LAN → FO or FO → E-LAN) Note: 2 units required per line! connection, 2 units needed for each line	111.9030.10
Interface E-LAN-FO: RS485/FO, Fiber optics: single-mode, max. transmission distance: 15 km, FO-connector: SC (E-LAN → FO or FO → E-LAN) Note: 2 units required per line! connection, 2 units needed for each line	111.9030.11
Time synchronisation:	
Radio controlled clock (DCF 77)	111.9024.01
GPS radio clock NIS time, RS485, Uh: AC 85 V ... 110V ... 264 V / DC 88 V ... 220V ... 280V	111.9024.45
GPS radio clock NIS time, RS485, Uh: DC 18 V ... 60V ... 72V	111.9024.46
GPS radio clock NIS time, RS232, Uh: AC 85 V ... 110V ... 264 V / DC 88 V ... 220V ... 280V	111.9024.47
GPS radio clock NIS time, RS232, Uh: DC 18 V ... 60V ... 72V	111.9024.48
Modems:	
INSYS EBW-L100, Router 4G / LTE	111.9049.04
Antenna for router	111.9049.01

REGSys™ Accessories	ID-No.
INSYS External antenna (magnetic base antenna)	111.9030.68
INSYS extension cable f. ext. antenna	111.9030.68.01
SHDSL Ethernet modem, (Westermo DDW-120) for establishing a TCP / IP connection via 2 – wire, 10..60V DC, DIN rail	111.9030.16
Power supply:	
Power supply Phoenix for DIN rail mounting: In: AC 120 ... 230 V, DC 90 ... 250 V, Out: 24 V/1.3 A	111.9030.73
Additional input and output module:	
Analogue input module (2 inputs)	320.0004.00
Analogue output module (2 outputs)	320.0003
Input module for tap-potentiometer total resistance 180 ...2 kΩ, min. 5 Ω/tap	320.0002.01
Input module for tap-potentiometer total resistance 2 ...20 kΩ, min. 50 Ω/tap	320.0002.03
Input module for PT100 in conformity with DIN 43760 in three-wire connection	320.0005.01
Operating manual:	
Additional operating manual for REG-D™ and PAN-D	GX
Additional operating manual for REG-D™ (please specify the language)	GX

Add-ons for REG-D™	ID-No.
Transformer Monitoring Module - TMM (REG-D™ only)	TMM
<ul style="list-style-type: none"> ● Consists of: <ul style="list-style-type: none"> Firmware update User guide and parameterisation software for Windows — Analogue module with two inputs for the temperature transducer — Input for PT100 in a three-wire connection in conformity with DIN 43760 	<p>A1</p> <p>A2</p>

Software for REG-D/PAN-D	ID-No.
REGView as CD-ROM	REGView
WinREG add-on functions Collector and RegView to archive and view data recorded with REG-D(A) and PAN-D.	
REGSim as CD-ROM, Simulates the parallel operation of transformers	REGSim

General add-ons	ID-No.
Profibus DP module incl. RS485 interface and connection cable	Profibus-DP
<ul style="list-style-type: none"> ● Mountable on DIN-rail (98 x 27 x 144) mm, ext. 24 V power supply adapter necessary 	B0
TCP/IP adapter (COMServer)	REG-COM
REG-COM Com-Server - Adapter Seriell to TCP/IP - 100 Mbit (8 HP / 3 U)	111.9037.24
Plug in unit with power supply: AC 100V ... 110V ... 240V / DC 24V ... 220V ... 240V	
Com-Server DIN rail power supply 24V/15W	111.9037.12
Com-Server 100BT, LC, 24 Volt AC/DC	111.9037.20
Com-Server 100BT, 3-way,12-24 Volt AC/DC	111.9037.08

General add-ons	ID-No.
<p>COM3 converter COM3 to Modbus converter to connect external devices with Modbus interface (RS485) to the transformer monitoring module. For example, to analyse the gas-in-oil ratio online, directly measure the winding temperature, etc.,</p> <ul style="list-style-type: none"> ● Auxiliary voltage AC 120 V...230 V, DC 90 ... 250 V, bundle of COM3 converter H2 and a power supply ● Auxiliary voltage DC 18 ... 72 V 	<p>COM3-MOD</p> <p>H1 H2</p>
<p>IRIG-DCF77 – converter</p> <p>IRIG - DCF77-Converter as plug in unit (10HP / 3U) Power supply: AC 100V ... 110V ... 240V / DC 100V ... 220V ... 300V</p>	<p>IRIG-DCF</p> <p>111.9024.21</p>
<p>Power supply adapter for REG-PE 3 U/6 HP, 15 Watt Must always be used when the 19" rack doesn't have a REGSys device or Usync and for module 2 when the 19" rack is not configured with an H11 device and a Usync is not integrated.</p> <p>REG-NTZ Power supply for REG-PE (3U / 6HP) - 15 Watt Voltage: AC 100V ... 110V ... 240V / DC 100V ... 220V ... 300V</p> <p>REG-NTZ Power supply for REG-PE (3U / 6HP) - 15 Watt Voltage: DC 20V ... 60V ... 70V</p>	<p>REG-NTZ</p> <p>111.9005.10</p> <p>111.9005.11</p>

A. Eberle GmbH & Co. KG

Frankenstraße 160
D-90461 Nuremberg

Tel.: +49-(0)911-62 81 08-0
Fax: +49-(0)911-62 81 08-96
E-mail: info@a-eberle.de

<http://www.a-eberle.de>

Provided by:
