

# Combined Earth Fault and Short Circuit Indicator

## EOR-1DS

- ▶ Short circuit indication (directed/undirected)
- ▶ Earth fault detection (transient and stationary)
- ▶ Low power sensor inputs
- ▶ Opt. incl. current sensors or 1A/5A transformers
- ▶ Fault recorder (max. 32 GB)



## 1. Application

The combined **earth fault and short circuit indicator** type EOR-1DS can be used in compensated, isolated, low ohmic and solidly earthed medium voltage networks.

**A core balanced current transformer (CBCT) is not necessary.** The sensors have to be mounted on shielded cables.

During the operational state, the indicator must be connected to an external power supply, which is allowed to fail in case of a fault. A long-life capacitor supplies the EOR-1DS for indication operation at minimum 4 h in case of a fault.

### 1.1 Earth fault detection

- **Transient earth fault detection** for compensated and isolated grids using the qu2 algorithms for
  - One time evaluation of the initial transient event at the beginning of an earth fault
  - Detection of low and high impedance faults
  - Elimination of circulating currents in ring feeder setups
- **Active power direction** or  $\cos(\varphi)$  method (suitable transducers required)
- **Reactive power direction** or  $\sin(\varphi)$  method
- **Pulse location**
  - Pulse location with complex evaluation
  - No separate core balanced current transformer (CBCT) necessary
  - Independent from detuning of Arc Suppression Coil (ASC)

### 1.2 Short circuit indication

For compensated, isolated and solidly earthed networks the EOR-1DS can be used as undirected short circuit indicator or as directed short circuit indicator.

- Phase selective short circuit indication
- Indication of short circuits to earth

### 1.3 SCADA connection

The EOR-1DS can be not only connected via four freely programmable relays and two fixed binary inputs (test, reset), but also with **Modbus RTU** protocol via RS485.

### 1.4 General Features

- OLED display
- Configuration in menu via turn/push control button, via MODBUS or via SD card with the help of a preconfigured parameter file
- Up to 32 GB memory for fault recording, log book and parameter set exchange via SD-card

### 1.5 Hardware variants



- EOR-1DS incl. 3 phase current sensors (SR55)
- EOR-1DS for low power sensors (only indicator)
- EOR-1DS with plug-on transd. 3IO + 3xLx (1 A / 5 A)
- EOR-1DS with plug-on transd. 3IO (1 A / 5 A)
- EOR-1DS with additional voltage adapter for classic 100 V measurement

## 2. Characteristics

### 2.1 qu2 algorithm (transient)

With the qu2 algorithm, transient earth faults can be selectively detected to a few k $\Omega$ . In the zero sequence system the healthy outputs can be considered as capacitors. To obtain a voltage shift  $u_{0(t)}$ , these capacitors have to be charged. This charge is created with the null current  $i_{0(t)}$  and results in the charge  $q_{0(t)}$ . With healthy outputs this yields the equation  $q_{0(t)} = C_0 u_{0(t)}$ . When  $u_{0(t)}$  is plotted on the x-axis and  $q_{0(t)}$  on the y-axis of the qu-graph, this gives a straight line for healthy outputs. This behavior does not apply for faulty outputs. Figure 1 shows this behavior for a low impedance earth fault.

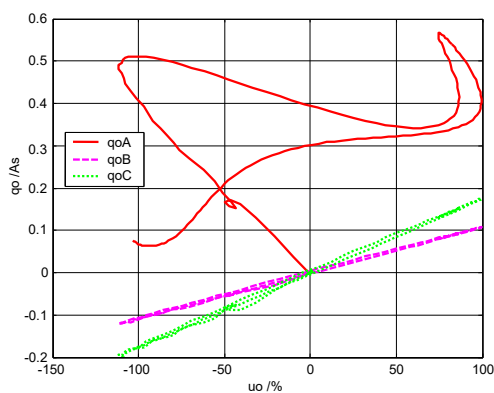

Figure 1: qu-graph for a low impedance earth fault

In parallel lines and meshed networks, circulating currents occur that can lead to an erroneous display. The improved qu2 algorithm eliminates this influence through linearization to the operating point and a downstream, non-linear filter. This algorithm is thus the first algorithm that really works in a meshed network and performs a successful, directional evaluation

This results in the following properties for the qu2 algorithm:

- Suitable for earth faults up to several k $\Omega$
- The triggering threshold of the voltage shift  $U_{NE}$
- The triggering current as an equivalent phase-earth capacitance
- Suppression of the earth fault in response to a selectable minimum duration of the earth fault (continuous earthing message)
- Recording of transient events in the logbook
- For the evaluation, either the measured or calculated  $U_{NE}$  from the three phase-earth voltages can be used
- Recording of the associated fault record with adjustable pre-event history (0 .. 1 s) and adjustable fault record length (0.. 3 s)

- Errors due to higher-frequency signals are greatly reduced by integral evaluation
- The qu2 algorithm, in comparison with the standard transient method, uses a much larger time range for the evaluation of the fault direction
- Reset of the indication by an external signal, in menu, automatically after a specified period or at the end of the earth fault

### 2.2 Reactive power direction method for isolated networks: $\sin(\varphi)$

- The trigger thresholds for the voltage shift  $U_{NE}$  and the total current  $3I_0$  are configurable
- For the evaluation, either the measured or the out of three phases calculated  $3I_0$  current can be used
- In the reactive power direction method, the requirements for the accuracy of the angle between current and voltage transformers are less.
- Reset of the indication by an external signal, in menu, automatically after a specified period or at the end of the earth fault

### 2.3 Active power direction method for compensated networks: $\cos(\varphi)$

- The trigger thresholds for the voltage shift  $U_{NE}$  and the total current  $3I_0$  are configurable
- Selectable operating modes:
  - Fault tracking indication of the direction of the active power in the null system
  - Stored indication of the active residual current increase
- When using the active power direction method, the accuracy of the angle between current and voltage transformers must be monitored
- Additional non-directional indication for inaccurate measurement ( $\geq$  cl. 1)
- Reset of the indication by an external signal, in menu, automatically after a specified period or at the end of the earth fault

## 2.4 Pulse location without overcompensation

For compensated networks that have installed appropriate pulse sources, which generate a pulse signal during stationary state of an earth fault.

The pulse location method is based on evaluation of the three phase currents. Thereby the pulse location algorithm of the EOR-1DS has significant advantages against classical pulse location devices:

- Pulse location with complex evaluation
- No separate core balanced current transformer (CBCT) necessary
- Independent from the detuning of the Petersen coil
- Pulse location with distributed Petersen coils possible
- correct results with symmetrical and unsymmetrical pulse signals also for high impedance faults
- Reset of the indication by an external signal, in menu, automatically after a specified period or at the end of the earth fault

## 2.5 Non-directional short circuit

- Adjustable activation threshold
- Reset of the indication by an external signal, in menu, automatically after a specified period or at the end of the short circuit

## 2.6 Directional short circuit

- Directional indication through evaluation of the phase-earth voltages
- Adjustable activation threshold
- reset of the indication by an external signal, in menu, automatically after a specified period or at the end of the short circuit

## 2.7 Applicability of the methods

The following table shows the applicability of the methods for the EOR-1DS, depending on the accuracy class of the transformers and sensors.

Available transformers / sensors			Transient qu2 (directional)	Pulse location (non-directional)	$\sin(\varphi)$ (directional)	$\cos(\varphi)$ (directional)	$\cos(\varphi)$ (directional + non-directional)	Short circuit (directional)	Short circuit (non-directional)	Short circuit to earth (directional)	Short circuit to earth (non-directional)
$I_0$	$3 \cdot I_L$	$3 \cdot U_L$									
	X			X					X		X
	X	X	X	X	X	X	X	X	X	X	X
X											X
X	X			X					X		X
X		X	X		X	X	X			X	X
X	X	X	X	X	X	X	X	X	X	X	X

Legend of minimum requirements for class of accuracy of transducers and sensors:	
	> cl. 1
	<= cl. 1
	<= cl. 0.5 + phase sensors / transducers preselected regarding error in amplitude and angle

## 2.8 SCADA connection

The EOR-1DS can be not only connected via four freely programmable relays and two fixed binary inputs (test, reset), but also with **Modbus RTU** protocol via RS485. In the standard register configuration all information and indications can be polled, as well as most of the parameters be set. Even during power supply fail all data points are still available (long life capacitor). Additional customer specific register assignments can be implemented.

## 2.9 Fault recorder with up to 32 GB

Fault records with a length of up to 4 seconds @ 2 kbps are recorded on the internal SD-card in case of a recognized short circuit or earth fault. During this, current, voltage and status messages are recorded. SD-cards with a memory size from 2 GB up to 32 GB are supported.

## 2.10 Logbook

- Displaying important messages directly on the EOR-1DS
- Detailed recording of the logbook on a supported SD card
- Recording in ASCII format and direct readable
- Events and changings in the configuration are recorded with a timestamp

## 2.11 Binary inputs

- 2 binary inputs with fixed functions (test and reset)
- Only use potential free

## 2.12 Binary outputs (relays)

- 4 free configurable relay outputs (bistable, NO/NC)
- Permanent/Immediate or wipe contact (time adjustable)
- All indication algorithm and the status are freely programmable on the relays
- Multiple signals can be combined (OR-operation)

### 3. Menu navigation

The EOR-1DS can be configured completely via the display menu (turn/push control button). The display normally is in standby mode, i.e. in switched off mode. By pushing the turn/push control button on the front side of the device the display is activated.

At first potentially existing short circuit and/or earth fault indications will be displayed by a three-phase screen.

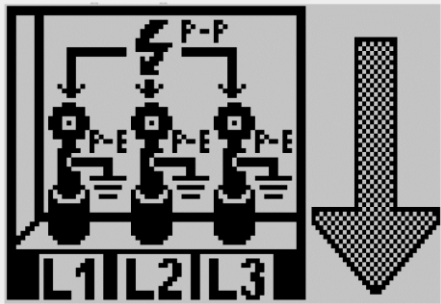

Figure 2: Three-phase short circuit in line direction

After pushing the turn/push control button overview displays will be shown. The different overview displays can be browsed by rotating the turn/push control button.

a-eberle		
Status:		
L1	Status	OK
L2	Status	OK
L3	Status	OK
E	Status	OK

Figure 3: Status L1, L2, L3 and earth conductor

a-eberle		
summary 1/2:		
methode	relay	
>I	ON	R12--
>Ie	OFF	R--3-
Wisch	OFF	R----
Puls.	ON	R---4

Figure 4: Summary short circuit and earth fault methods incl. assigned relays

In the following screens the current values of measured currents, voltages and phase angles of all three phases as well as the zero sequence system and the total power for P, Q and S and the phases and zero sequence system are displayed.

a-eberle		
current:		
I1	23	A
I2	22	A
I3	23	A

a-eberle		
Vol.   Unom = 20 kV		
U1	11.7	KV
U2	11.6	KV
U3	11.7	KV

a-eberle		
3I0, U0, φ0		
3I0	0.8	A
U0	0.2	KV
φ0	0.5	°

a-eberle		
active power:		
P1	120	kW
P2	123	kW
P3	119	kW
P0	3	kW

Figure 5: Summary of current, voltage, zero sequence system and active power

By pushing the turn/push control button again the main menu can be entered, in which all parameters can be set.

➔ 1	
Main Menu:	
setting	
➔ test/reset	
system	
display off	
SD card	
back	

Figure 6: Main menu for parameterization

## 4. Technical specifications

### 4.1 Regulations and standards

DIN EN 61010-1:2020-03  
 DIN EN 61010-2-030:2011-07  
 DIN EN 61326-1:2013  
 CISPR 11:2015 (EN55011)



### 4.2 AC voltage input LRM

#### Capacitive voltage tap-off on LRM systems

Measuring voltage	0 ... 60 VAC
Shape of the curve	Sine
Frequency range of the fundamental wave	48 ... 52 Hz
Burden	10 MΩ
Accuracy	± 3 %

### 4.3 AC voltage input low power U06

Low power sensors with 200 kΩ rated burden and  $U_r = 3,25 \text{ V} / \sqrt{3}$  e.g. sensors from ABB, Greenwood-Power, Zelisko, etc. ( $U_n$  settable)

Measuring voltage	0 ... 4 VAC
Shape of the curve	Sine
Frequency range of the fundamental wave	48 ... 52 Hz
Burden	200 kΩ
Accuracy	± 1 %

### 4.4 AC voltage input low power U07

Low power sensors with 2 MΩ rated burden and  $U_r = 3,25 \text{ V} / \sqrt{3}$  e.g. sensors from ABB, Greenwood-Power, Zelisko, etc. ( $U_n$  settable)

Measuring voltage	0 ... 4 VAC
Shape of the curve	Sine
Frequency range of the fundamental wave	48 ... 52 Hz
Burden	2 MΩ
Accuracy	± 1 %

### 4.5 AC voltage input U10

Classical voltage transducers with 100 V or 110 V; all values refer to the connection at the U10 adapter; AC voltage input at indicator itself like U06

Measuring voltage	0 ... 150 VAC
Shape of the curve	Sine
Frequency range of the fundamental wave	48 ... 52 Hz
Burden	10 MΩ
Accuracy	± 1.5 %

### 4.6 AC current input low power C10

Inductive low power sensors with  $U_r = 225 \text{ mV}$ , e.g. sensors from ABB, Greenwood-Power, Zelisko, etc. ( $U_n$  settable)

Measuring voltage	0 ... 420 mVAC
Shape of the curve	Sine
Frequency range of the fundamental wave	48 ... 52 Hz
Internal consumption	Burden 1 MΩ
Accuracy	± 1 %

### 4.7 AC current input C11

#### SR55 Rogowski phase current transformer

Measuring current	0 ... 2500 A
Shape of the curve	Sinus
Frequency range of the fundamental wave	48 ... 52 Hz
Accuracy	± 3 %
Cable length	8 m
Conductor diameter	13 – 55 mm
Conductor type	<ul style="list-style-type: none"> <li>• Only for shielded conductors</li> <li>• Conductor shield (ground) must be led back for each phase, so a current on the shield does not influence the measurement</li> </ul>

## 4.8 AC current input C21/C25

Classical current transducers 1 A / 5 A secondary; all values regarding the connection at the C21 or C25 adapter

Measuring voltage	0 ... 12 A
Shape of the curve	Sinus
Frequency range of the fundamental wave	48 ... 52 Hz
Internal consumption	≤ 0.1 VA
Accuracy	± 1 %
Overload capacity	10 A continuous 30 A for 10 s 60 A for 1s 500 A for 5 ms

## 4.9 Binary inputs

Input voltage	Potential free
---------------	----------------

## 4.10 Binary outputs

Electrical isolation	Electrically isolated from all other device inter potentials
Contact load (maximal values for ohmic load)	AC 150 V / 0,4 A DC 30 V / 2 A DC 150 V / 0,25 A
Minimal switching voltage	1 mV
Amount of switching operation	>10 <sup>5</sup> electrical
Type	Bistable relays, programable as NO or NC contact

## 4.11 Serial RS485 interface

Typ	2-wire RS485 interface
Potential isolation	galvanic separated
Connection	shielded cabel
120 Ω termination	No termination included; use external termination if needed

## 4.12 Supply voltage

DC	20 V – 240 V
AC	48 V – 240 V
Power consumption DC	0,6 W (max 1,0 W)
Power consumption AC	1,9 VA (max 2,6 VA)
Indication operation by long-life capacitor - without flashing light and display OFF	Min. 12 h
Indication operation by long-life capacitor - with flashing light and display OFF	Min. 4 h
Indication operation by long-life capacitor - display ON	Min. 7 min

## 4.13 Conductor nominal values

Length of wire end ferrule or stripped wire	8 to 10 mm
Diameter with wire end ferrule	1 mm <sup>2</sup>
Diameter without wire end ferrule	1,5 mm <sup>2</sup>

## 4.14 Limit value monitoring

Limit value	Programmable
Response time	Programmable
Alarm displays	Programmable: relays, display

## 4.15 Measurement value recording

Non-volatile	≤ 32 GB
--------------	---------

## 4.16 Environmental parameters

Reference temperature	23°C ± 1 K
Function	-20 °C ... +65 °C
Transport and storage	-25 °C ... +65 °C
Relative humidity	5% ... 95% not condensing
Operating altitude a. s. l.	Up to 2000 meters

We take care of it.

---

## 4.17 Weight

EOR-1DS C10 without adapter	0.19 kg
EOR-1DS C11 with 3x Rogowski sensors	1.24 kg
EOR-1DS C21/C25 with plug-on transd.	0.31 kg
EOR-1DS C21/C25 with U10 Adapter	0.48 kg

## 4.18 Electrical safety

DIN EN 61010-1:2020-03

DIN EN 61010-2-030:2011-07

Protection class	IP40
Protection category	II
Pollution degree	2
Measurement category (only U10-adapter)	III/150 V
Measurement category (only U10-adapter)	II/300 V
Overvoltage category	II

### Working voltages

50 V	150 V	240 V
Low power inputs, LRM input	Relay outputs	Power supply

## 4.19 Electromagnetic compatibility

Immunity	DIN EN 61326-1:2013
Emission	CISPR11 (EN55011)



## 4.20 Special features EOR-1DS

- SD card behind removable front, for access release the screw on the front side
- In contrast to the EOR-1D, there is no battery behind the removable front, because the battery was replaced with a long life capacitor
- SD card useable for firmware updates, parameter updates, fault record and logbook



Figure 7: EOR-1DS with demounted front plate for SD card access

## 4.21 Indicator dimensions

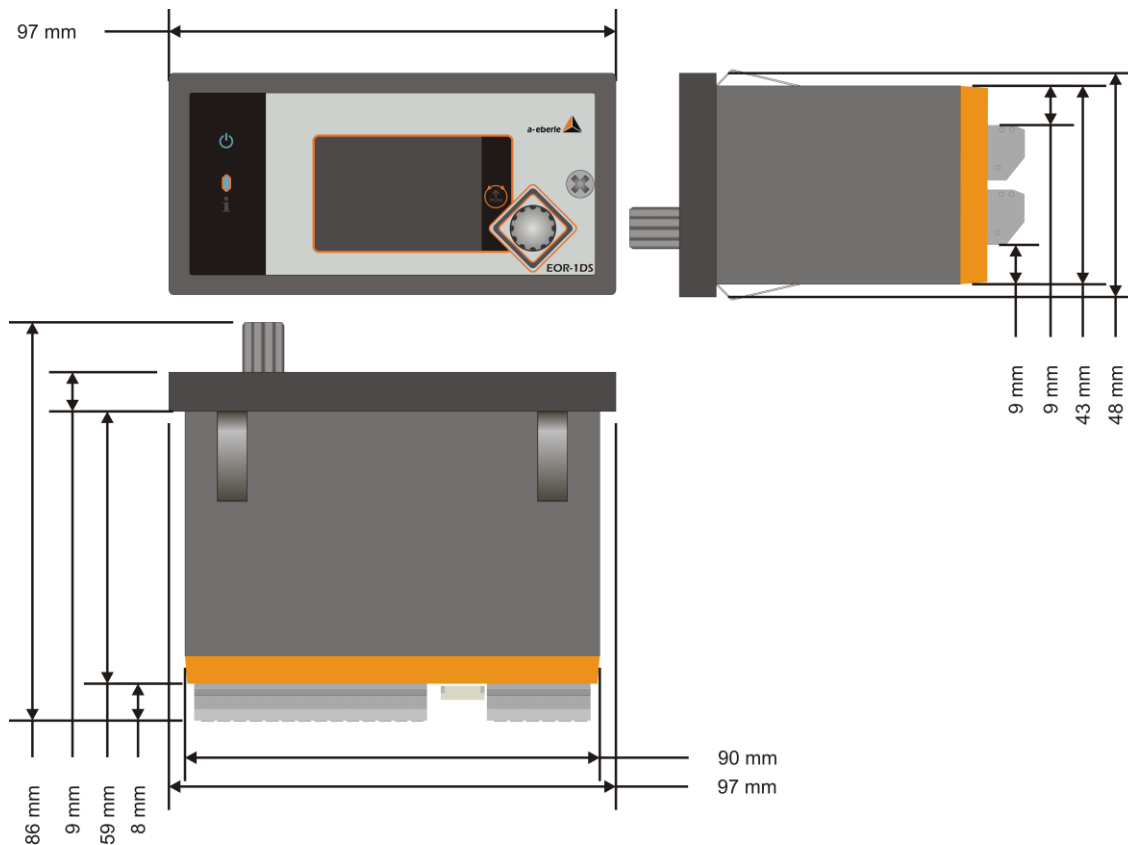

Figure 8: Dimensions EOR-1DS



### Necessary panel cutout

92+0,8 mm x 45+0,6 mm (IEC 61554 / DIN 43700)

## 4.22 Dimensions phase current sensors (part of EOR-1DS art. 119.9006.11xx)



Figure 9: Installation phase current sensor

**ATTENTION!**  
Conductor shield must be led back

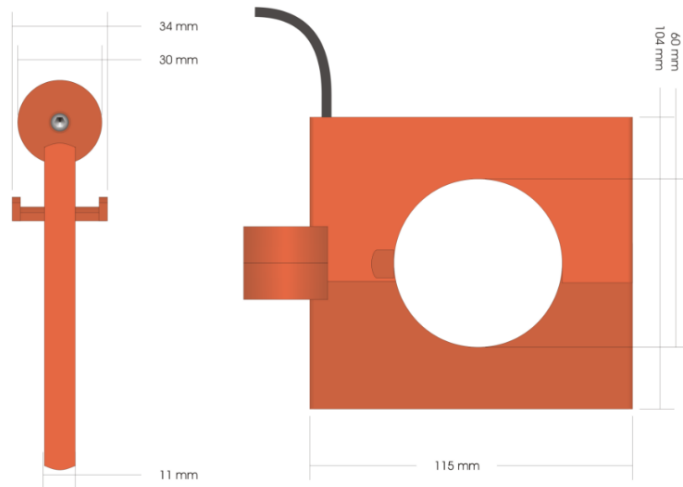

Figure 10: Dimensions phase current sensor

3x Rogowski coil sensors included in set with article number 119.9006.11xx

## 4.23 Dimensions current adapter C21/C25 and voltage adapter U10

The following pictures show the current adapter C21 for classical current measurement of 1 A / 5 A values and the voltage adapter U10 for classical voltage measurement of 100 / 110 V. Feature C25 has in comparison with feature C21 only the 3I<sub>0</sub> current transducer. The adapters can be mounted with the help of a device frame on the top of the device or with a DIN rail adapter separately.

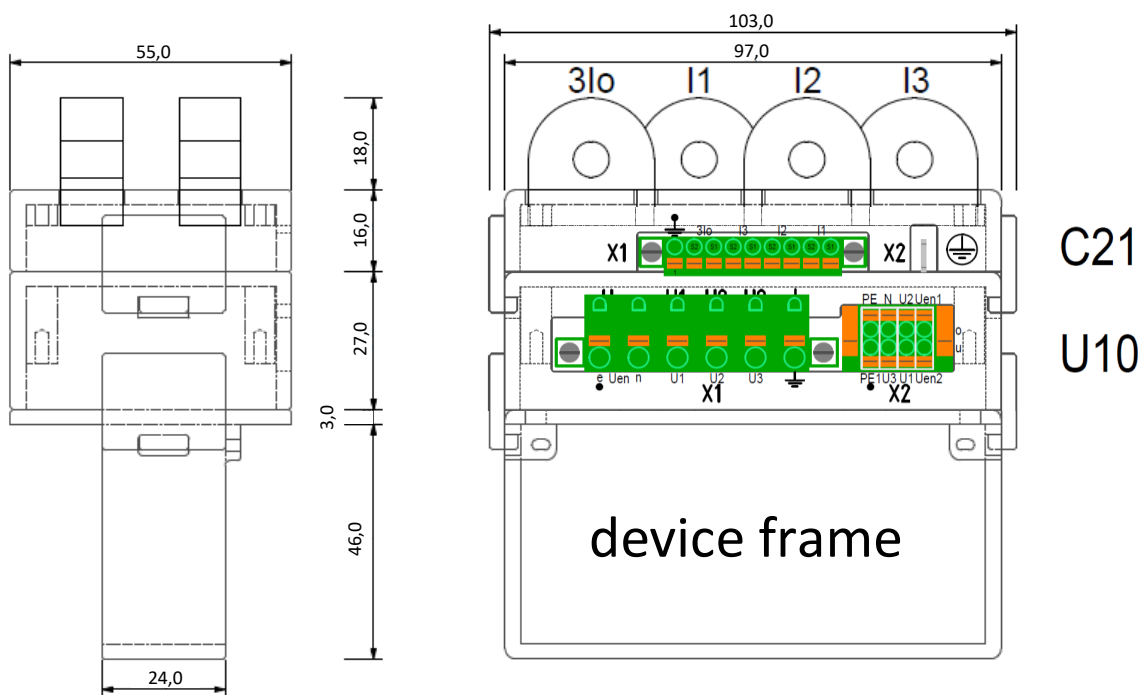

Figure 11: C21 adapter for current measurement 1A / 5A and U10 adapter for voltage measurement 100 V / 110 V incl. frame for mounting on EOR-1DS device

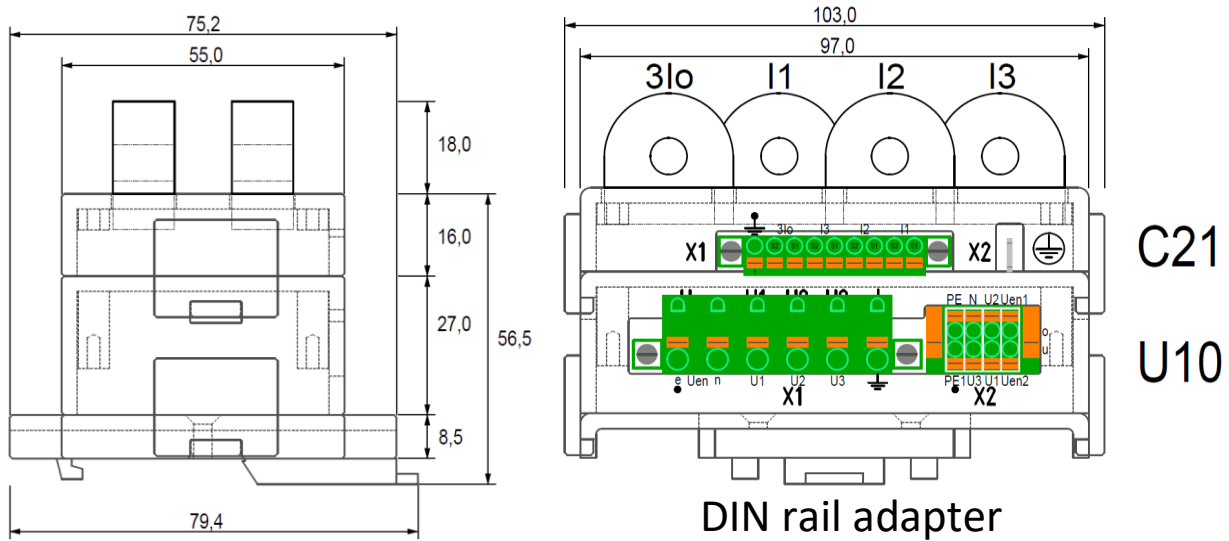

Figure 12: C21 adapter for current measurement 1A / 5A and U10 adapter for voltage measurement 100 V / 110 V incl. DIN rail adapter for separate mounting

We take care of it.

## 4.24 Terminal assignment indicator

PIN	Function
1	Modbus GND
2	Modbus A
3	Modbus B
4	Reset extern (use only potential free)
5	Common (Reset extern / Test extern)
6	Test extern (use only potential free)
7	Current sensor L1
8	Current sensor L1 GND
9	Current sensor L2
10	Current sensor L2 GND
11	Current sensor L3
12	Current sensor L3 GND
13	Current sensor 3I0
14	Current sensor 3I0 GND

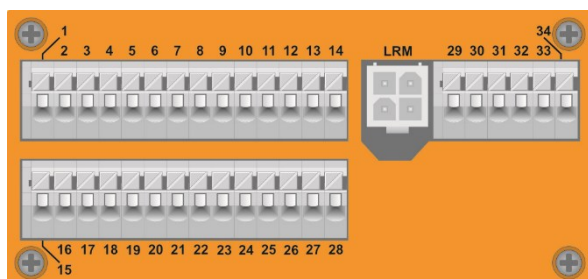



Figure 13: Pins EOR-1DS

PIN	Function
LRM	4 pin socket for LRM system (U-measurement)
29	Voltage sensor L1
30	Voltage sensor GND
31	Voltage sensor L2
32	Voltage sensor GND
33	Voltage sensor L3
34	Voltage sensor GND

PIN	Function
15	Auxiliary voltage 20..240 VDC / 48..240 VAC
16	Auxiliary voltage 20..240 VDC / 48..240 VAC
17-19	not used
20	Flashing lights BL4.1/BL6/BL7 (brown)
21	Flashing lights BL4.1/BL6/BL7 (white)
22	not used
23	not used
24	Relays 1..4 Common
25	Relay 1 / status
26	Relay 2
27	Relay 3
28	Relay 4

## 4.25 Terminal assignment C21/C25 current adapter

No.	Name	Function	Colour Code	Connector adapter	Connector EOR-1DS	Cross-section
X1	Phase current L1	I1 - S1	white	X1-9	X5-10o	0,5 – 1,5 mm <sup>2</sup>
		I1 - S2	brown	X1-8	X5-10u	
	Phase current L2	I2 - S1	green	X1-7	X5-11o	
		I2 - S2	yellow	X1-6	X5-11u	
	Phase current L3	I3 - S1	grey	X1-5	X5-12o	
		I3 - S2	pink	X1-4	X5-12u	
	Zero sequence current 3I0	3I0 - S1	blue	X1-3	X5-13o	
3I0 - S2		red	X1-2	X5-13u		
	Cable shield	Cable shield	black	X1-1	-	
	grounding cable shield	Cable shield	free choice	Flat connector 6,3 mm	PE	2,5 mm <sup>2</sup>

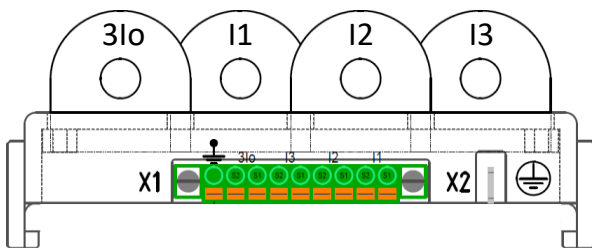

Figure 14: Connection terminals current adapter C21 (3I0 + I1..3) or. C25 (only 3I0)

## 4.26 Terminal assignment U10 voltage adapter

No.	Name	Function	Colour Code	Connector adapter	Connector EOR-1DS	Cross section
X1	Zero voltage U0	Uen - e	-	X1-1	-	0,5 – 2,5 mm <sup>2</sup>
		Uen - n	-	X1-2	-	
	Phase voltage L1	U1	-	X1-3	-	
	Phase voltage L2	U2	-	X1-4	-	
	Phase voltage L3	U3	-	X1-5	-	
	Measurement reference $\perp$	Mess-PE	-	X1-6	-	
X2	Zero voltage U0	n.a.	-	-	-	0,5 – 1,5 mm <sup>2</sup>
		n.a.	-	-	-	
	Phase voltage L1	U1	white	X2-3u	X5-6o	
	Phase voltage L2	U2	brown	X2-3o	X5-7o	
	Phase voltage L3	U3	green	X2-2u	X5-8o	
	Measurement reference $\perp$	PE	yellow	X2-2o	X5-7u	
	Cable shield	Cable shield	black	X2-1u	-	
	Grounding cable shield	Cable shield	free choice	X2-1o	-	

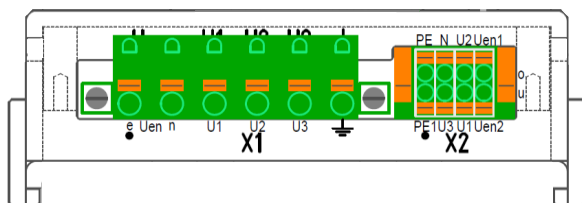

Figure 15: Connection terminals U10 voltage adapter for 100 / 110 V

## 5. Accessories for EOR-1DS

### 5.1 External flashing lights

Optional the external flashing lights type BL4.1 and BL7 for wall mounting and BL6 for surface mounting are available. Typ BL7 verfügt zusätzlich über eine Richtungsanzeige.



Figure 1: Type BL4.1



Figure 2: Type BL7



Figure 3: Type BL6

Type	Description	Cable length	Article number
<b>BL4.1</b>	Without direction indication for wall mounting	6m	119.9100.06
<b>BL7</b>	With direction indication for wall mounting	6m	119.9103.06
<b>BL6</b>	Without direction indication for surface mounting	6m	119.9102.06

### 5.2 LRM Adapter cables

In addition, the following LRM – adapter cables are available optionally for connection of the voltage of a LRM – system to the AMP socket of the EOR-1DS:



Figure 4: LRM adapter



Figure 5: Y-LRM adapter

Type	Description	Article number
<b>LRM adapter</b>	4 pole AMP-socket on both ends	582.8114.xx
<b>Y-LRM adapter</b>	3x flat plug / socket on 4 pole AMP socket	582.8113.xx



The EOR-1DS does not provide a second capacity for measurement of the voltage on a capacitive voltage divider. An appropriate device has to be used that provides a capacity corresponding to the capacitive voltage divider (e.g. Capdis or WEGA system). The EOR-1DS can only be connected in parallel to such a device with a LRM – adapter cable.

## 5.3 Low power sensors

### Zelisko sensor (split core type) 1 set (3 pcs.)

Phase current sensor (split core type) for power and short circuit measurement 300 A / 0.225 V cl. 0.5 up to 200 % afterwards 5P10 (Inner-Ø: 55 mm). Also available as preselected set.

Sensor type	Cable length	Article no.
SMCS/T-JW1002	3.7m	330.1510
SMCS/T-JW1002 preselected	3.7 m	330.1510.00



### Zelisko sensor (split core type) Core Balanced Current Sensor (3Io)

Core Balanced Current Sensor for 3Io measurement with a ratio of 60 A / 0.225 V; (Inner-Ø: 120 mm), cl. 0.5.

Sensor type	Cable length	Article no.
GAE120/SENS-JW1003	3.7m	330.1515



### Zelisko combined current and voltage sensor (up to 12/24/36 kV) for open air facility

The open facility sensor combines the functions of a current and voltage sensor in one device. Due to the construction design and the special cast resin mixture the product can be used outdoors. The combined sensor is available up to an isolation level of 36 kV. (current sensor cl. 0.5 5P20 / voltage sensor cl 0.5 3P)

Sensor type	Cable length	Article no.
SMVS-K1112 (<= 12 kV isol. level)	-	330.1512.12
SMVS-K1112 (<= 24 kV isol. level)	-	330.1512.24
SMVS-K1112 (<= 36 kV isol. level)	-	330.1512.36



## 5.4 Current transducers with low nominal load

Phase current transformer for load current and short circuit detection ELEQ TQ50 (Inside- Ø: 42 mm, rated burden 0,5 VA)

Transducer type	Cable length	Article no.
250/1 A (Kl.1)	5,0 m	330.1502
300/1 A (Kl.1)	5,0 m	330.1503
400/1 A (Kl.0,5)	5,0 m	330.1504
500/1 A (Kl.0,5)	5,0 m	330.1505
600/1 A (Kl.0,5)	5,0 m	330.1506



## 6. Order specifications

### For determining the order details:

- Only one unit can be ordered for codes with the same capital letter.
- When a code's capital letter is followed only by zeros, the code may be omitted.

Characteristic	CODE
<p><b>Combined short circuit &amp; earth fault indicator EOR-1DS</b></p> <ul style="list-style-type: none"> <li>● For undirected and directed short circuit and earth fault indication with fault records and logbook on SD card for easy fault analysis</li> <li>● Power meter</li> <li>● Switch panel mounting with 4 relays and 2 binary inputs</li> <li>● Low power voltage sensor inputs 3x ULx and Low power current sensor inputs 1x 3I0 + 3x ILx</li> <li>● Push-in terminals</li> <li>● LRM interface for capacitive voltage input</li> <li>● Incl. MODBUS RTU protocol</li> <li>● 8GB-Flash-memory</li> <li>● Wide-range power supply, long-life capacitor for &gt;4h indication operation</li> </ul>	EOR-1DS
<p><b>Input configuration current</b></p> <ul style="list-style-type: none"> <li>● Without additional current sensors Art.-No.: 119.9006.10xx</li> <li>● Current measurement via rogowski coil sensors directly at medium voltage cables; Incl. 3 phase current sensors with each <b>8 m connection cable</b>, no core balanced CT required Art.-No.: 119.9006.11xx</li> <li>● Current measurement via rogowski coil sensors directly at medium voltage cables; Incl. 3 phase current sensors with each <b>4 m connection cable</b>, no core balanced CT required Art.-No.: 119.9006.12xx</li> <li>● Incl. plug-on adapter (art.no. 119.8881.21) for 4 units CTs for 1A / 5A (1 x 3I0, 3 x ILx), mounting via <b>frame</b> at the top of the device, connection cable length with 0.3m / 1.5m / 3.0m free chooseable Art.-No.: 119.9006.21xx.xx</li> <li>● Incl. plug-on adapter (art.no. 119.8881.21) for 4 units CTs for 1A / 5A (1 x 3I0, 3 x ILx), mounting via <b>DIN-rail adapter</b>, connection cable length with 0.3m / 1.5m / 3.0m free chooseable Art.-No.: 119.9006.21xx.xx</li> <li>● Incl. plug-on adapter (art.no. 119.8881.25) for 1 unit CT for 1A / 5A (1 x 3I0) (EWR22 replacement), mounting via <b>frame</b> at the top of the device, connection cable length with 0.3m / 1.5m / 3.0m free chooseable Art.-No.: 119.9006.25xx.xx</li> <li>● Incl. plug-on adapter (art.no. 119.8881.25) for 1 unit CT for 1A / 5A (1 x 3I0) (EWR22 replacement), mounting via <b>DIN-rail adapter</b>, connection cable length with 0.3m / 1.5m / 3.0m free chooseable Art.-No.: 119.9006.25xx.xx</li> </ul>	<p>C10</p> <p>C11</p> <p>C12</p> <p>C21.Fxx</p> <p>C21.Dxx</p> <p>C25.Fxx</p> <p>C25.Dxx</p>



Characteristic	CODE
<p><b>Input configuration voltage</b></p> <ul style="list-style-type: none"> <li>● Low power voltage sensor inputs with 200 kΩ burden Art.-No.: 119.9006.xx06</li> </ul> <p>Low power voltage sensor inputs with 2 MΩ burden Art.-No.: 119.9006.xx07</p> <ul style="list-style-type: none"> <li>● 4 voltage inputs up to 120V for classical 100V VT (incl. external adapter (art.no. 119.8881.10), mounting via <b>frame</b> at the top of device, connection cable length with 0.3m / 1.5m / 3.0m free chooseable) Art.-No.: 119.9006.xx10.xx</li> <li>● 4 voltage inputs up to 120V for classical 100V VT (incl. external adapter (art.no. 119.8881.10), mounting via <b>DIN-rail adapter</b>, connection cable length with 0.3m / 1.5m / 3.0m free chooseable) Art.-No.: 119.9006.xx10.xx</li> </ul>	<p>U06</p> <p>U07</p> <p>U10.Fxx</p> <p>U10.Dxx</p>
<p><b>Customer specific parameterization</b></p> <ul style="list-style-type: none"> <li>● Without</li> <li>● With</li> </ul>	<p>K0</p> <p>K1</p>

Accessories	article number
<p><b>Adapter for DIN-rail mounting of the EOR-1DS</b></p> <ul style="list-style-type: none"> <li>● Mounting the EOR-1DS on an existing DIN-rail, set of 2 DIN-rail adapters (left and right housing side), existing screws of EOR-1DS (rear side) must be re-used to mount the adapter on the EOR-1DS</li> </ul>	<p>564.0495</p>
<p><b>Adapter cable EOR-1DS</b></p> <ul style="list-style-type: none"> <li>● LRM Y-adapter cable for 4,8 mm flat socket <ul style="list-style-type: none"> <li>○ cable length 0,3 m</li> <li>○ cable length 1,0 m</li> <li>○ cable length 1,5 m</li> </ul> </li> <li>● LRM connection cable for 2 x 4-pol socket <ul style="list-style-type: none"> <li>○ cable length 0,3 m</li> <li>○ cable length 1,0 m</li> <li>○ cable length 1,5 m</li> </ul> </li> </ul>	<p>582.8113.03</p> <p>582.8113.10</p> <p>582.8113.15</p> <p>582.8114.03</p> <p>582.8114.10</p> <p>582.8114.15</p>
<p><b>Flashing lights EOR-1DS</b></p> <ul style="list-style-type: none"> <li>● BL6 without direction indication for surface mounting, cable length 6 m</li> <li>● BL4.1 without direction indication for wall mounting, cable length 6 m</li> <li>● BL7 with direction indication for wall mounting, cable length 6 m</li> </ul>	<p>119.9102.06</p> <p>119.9100.06</p> <p>119.9103.06</p>

We take care of it.

Accessories	article number
<p><b>Low power sensors (see also chapter 5.3)</b></p> <ul style="list-style-type: none"> <li>● 1 set (3 pcs.) sensors, split core type <ul style="list-style-type: none"> <li>○ Zelisko SMCS/T-JW1002, length of conn. cable 3.7 m</li> <li>○ Zelisko SMCS/T-JW1002, preselected, length of conn. cable 3.7 m</li> </ul> </li> <li>● 1x Core Balanced Current Sensor (3Io), split core type <ul style="list-style-type: none"> <li>○ Zelisko GAE120/SENS-JW1003, length of conn. cable 3.7 m</li> </ul> </li> <li>● 1x combined current and voltage sensor (up to 12/24/36 kV) for open air facility <ul style="list-style-type: none"> <li>○ Zelisko SMVS-K1112 (up to 12 kV isolation level)</li> <li>○ Zelisko SMVS-K1112 ( up to 24 kV isolation level )</li> <li>○ Zelisko SMVS-K1112 ( up to 36 kV isolation level )</li> </ul> </li> </ul>	<p>330.1510 330.1510.00  330.1515  330.1512.12 330.1512.24 330.1512.36</p>
<p><b>Current transducers with low nominal load (see also chapter 5.4)</b></p> <ul style="list-style-type: none"> <li>● Phase current transformer für load current and short circuit detection ELEQ TQ50 (Inside-Ø: 42mm, rated burden 0.5 VA) <ul style="list-style-type: none"> <li>○ ELEQ TQ50 250/1 A (cl.1), length of connection cable 5.0 m</li> <li>○ ELEQ TQ50 300/1 A (cl.1), length of connection cable 5.0 m</li> <li>○ <b>ELEQ TQ50 400/1 A (cl.0.5), length of connection cable 5.0 m</b></li> <li>○ ELEQ TQ50 500/1 A (cl.0.5), length of connection cable 5.0 m</li> <li>○ ELEQ TQ50 600/1 A (cl.0.5), length of connection cable 5.0 m</li> </ul> </li> </ul>	<p>330.1502 330.1503 <b>330.1504</b> 330.1505 330.1506</p>
<p><b>Additional C21 &amp; U10 adapter, connection cables and mounting sets</b></p> <ul style="list-style-type: none"> <li>● C21 adapter</li> <li>● C25 adapter</li> <li>● U10 adapter</li> <li>● C21 or C25 connection cable length: 0.3 m</li> <li>● C21 or C25 connection cable length: 1.5 m</li> <li>● C21 or C25 connection cable length: 3.0 m</li> <li>● U10 connection cable length: 0.3 m</li> <li>● U10 connection cable length: 1.5 m</li> <li>● U10 connection cable length: 3.0 m</li> <li>● Mounting set frame on the top of the device for C21/C25/U10 adapter</li> <li>● Mounting set DIN-rail adapter C21/C25/U10 adapter</li> </ul>	<p>119.8881.21 119.8881.25 119.8881.10 582.8221.03 582.8221.15 582.8221.30 582.8210.03 582.8210.15 582.8210.30 564.0801.51 564.0802.50</p>

# Notes

---

---

---

---

---

---

---

---

---

---

---

---

---

---

---

---

---

---

---

---

---

---

---

---

---

---



A. Eberle GmbH & Co. KG

Frankenstraße 160

D-90461 Nürnberg

Tel.: +49 (0) 911/62 81 08-0

Fax: +49 (0) 911/62 81 08 96

E-Mail: [info@a-eberle.de](mailto:info@a-eberle.de)

<http://www.a-eberle.de>

Edition of: 26.02.2025

Version: TD\_EOR-1DS\_EN\_20250226.docx

**Copyright 2013 - 2025 A. Eberle GmbH & Co. KG**

Subject to change without prior notice.